

67 **Wrenches & Torque Wrenches**

**Hi-Performance Combination Wrench 15° Offset**

- Chrome Vanadium Alloy Steel
- Thin profile head and ring for easy access in confined spaces
- Light weight model
- High torque performance as over 1.6 times as ANSI & DIN standard
- Satin chrome finished for maximum durability and corrosion resistance



• SAE



• METRIC

ITEM NO.	Satin	SIZE(Inch)	L(mm)	Satin Chrome Finished	
				🔧	📦
ACEX0808		1/4	104	10	320
ACEX1010		5/16	124	10	320
ACEX1111		11/32	131	10	320
ACEX1212		3/8	143	10	320
ACEX1414		7/16	151	10	240
ACEX1616		1/2	169	10	120
ACEX1818		9/16	180	10	120
ACEX2020		5/8	198	10	80
ACEX2222		11/16	206	10	80
ACEX2424		3/4	223	10	80
ACEX2626		13/16	236	10	80
ACEX2828		7/8	255	5	40
ACEX3030		15/16	274	5	40
ACEX3232		1	284	5	40
ACEX3434		1-1/16	304	5	30
ACEX3636		1-1/8	315	5	30
ACEX4040		1-1/4	355	5	20

**STORAGE RACK**  
15° Offset Hi-Performance Combination Wrench Set



Satin Chrome Finished

ITEM NO.	CONTENTS	🔧	📦 (SET)
GBAC1201	1/4", 5/16", 11/32", 3/8", 7/16", 1/2", 9/16", 5/8", 11/16", 3/4", 13/16", 7/8"	5	(SET)

**STORAGE RACK**  
15° Offset Hi-Performance Combination Wrench Set



9PCS



12PCS



14PCS

ITEM NO.	CONTENTS	🔧	📦 (SET)
GAAC0901	6, 7, 8, 10, 12, 13, 14, 17, 19	5	(SET)
GAAC1201	6, 7, 8, 9, 10, 11, 12, 13, 14, 15, 17, 19	5	(SET)
GAAC1401	6, 7, 8, 9, 10, 11, 12, 13, 14, 15, 17, 19, 22, 24	5	(SET)

Satin Chrome Finished

**HI-PERFORMANCE  
COMBINATION WRENCH**

**POUCH BAG - BLACK**  
15° Offset Hi-Performance Combination Wrench Set

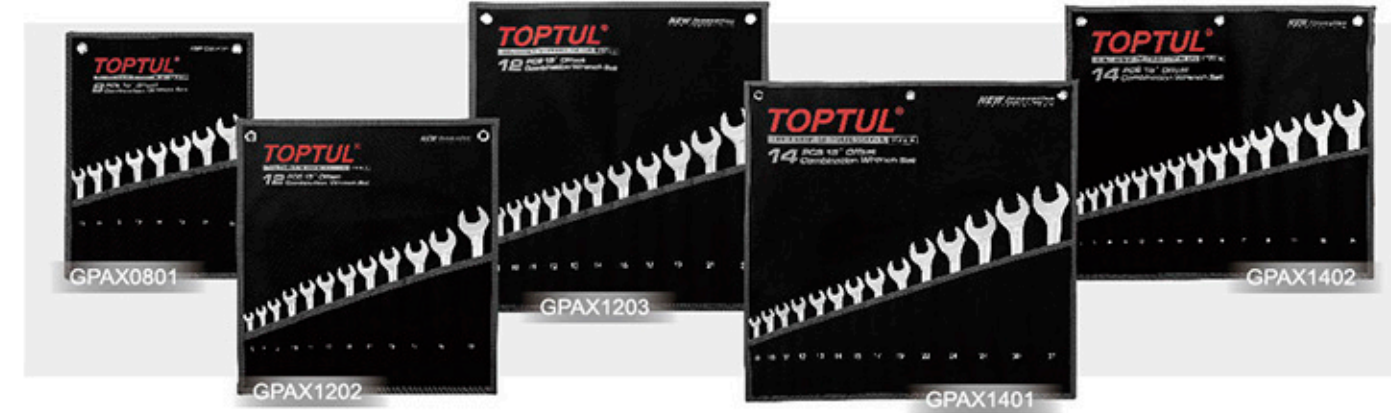

ITEM NO.	CONTENTS	🔧	📦 (SET)
GPAX0801	10, 11, 12, 13, 14, 15, 17, 19	20	(SET)
GPAX1202	6, 7, 8, 10, 11, 12, 13, 14, 15, 17, 19, 22	10	(SET)
GPAX1203	8, 9, 10, 11, 12, 13, 14, 16, 17, 19, 21, 24	10	(SET)
GPAX1401	8, 10, 11, 12, 13, 14, 15, 17, 19, 22, 24, 27, 30, 32	4	(SET)
GPAX1402	8, 9, 10, 11, 12, 13, 14, 15, 16, 17, 19, 21, 22, 24	10	(SET)

Satin Chrome Finished

ITEM NO.	CONTENTS	🔧	📦 (SET)
GPAX1403	6, 7, 8, 10, 12, 13, 14, 17, 19, 22, 24, 27, 30, 32	6	(SET)
GPAX1601	6, 7, 8, 9, 10, 11, 12, 13, 14, 15, 17, 19, 22, 24, 27, 30, 32	4	(SET)
GPBX1601	1/4", 5/16", 3/8", 7/16", 1/2", 9/16", 5/8", 11/16", 3/4", 13/16", 7/8", 15/16", 1", 1-1/16", 1-1/8", 1-1/4"	4	(SET)
GPAX2601	6, 7, 8, 9, 10, 11, 12, 13, 14, 15, 16, 17, 18, 19, 20, 21, 22, 23, 24, 25, 26, 27, 28, 29, 30, 32	3	(SET)

Satin Chrome Finished



**POUCH BAG - BLACK**  
15° Offset Hi-Performance Combination Wrench Set



ITEM NO.	CONTENTS	🔧	📦 (SET)
GPCX0801	8, 10, 12, 13, 14, 17, 19, 22	10	(SET)

Satin Chrome Finished

**METAL BOX**  
15° Offset Hi-Performance Combination Wrench Set



ITEM NO.	CONTENTS	🔧	📦 (SET)
GAAD1603	6, 7, 8, 9, 10, 11, 12, 13, 14, 15, 16, 17, 18, 19, 22, 24	3	(SET)

Satin Chrome Finished

METAL CASE: W445 x D188 x H50 (mm)

69 Wrenches & Torque Wrenches

Super-Torque Combination Wrench 15° Offset



**- AAEX SERIES -  
HI-PERFORMANCE COMBINATION WRENCH**  
FOR AUTOMOTIVE REPAIR & MAINTENANCE  
(Thin and light weight model for quick tightening & loosening applications)

**- AAEW SERIES -  
SUPER-TORQUE COMBINATION WRENCH**  
FOR HEAVY DUTY INDUSTRIAL APPLICATIONS  
(Strong model for toughest tightening & loosening jobs)

■ **More Efficient Open-End Design**  
The improved design of 15 degree bending open-end offers a better tightening and untightening accessibility.

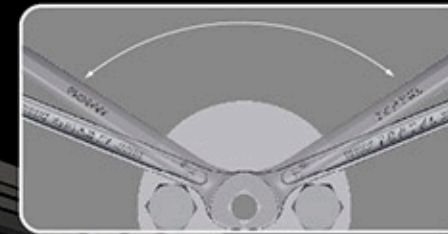

■ **Better Ring Head Accessibility**  
Specially designed ring head provides better clearance for reaching recessed spaced nuts.



■ **Extra Comfort & Effective Grip**  
Larger side handle and recess frame handle design maximize the contact comfort with the hand.

Super-Torque Combination Wrench 15° Offset

- Chrome Vanadium Alloy Steel
- Robust construction design to work under extreme conditions
- High torque performance as over 2 times as ANSI & DIN standard
- Satin chrome finished for maximum durability and corrosion resistance

POUCH BAG - BLACK

15° Offset Super-Torque Combination Wrench Set

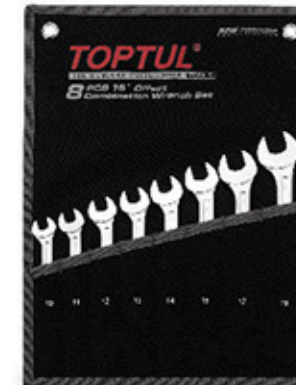

\* METRIC



\* SAE

ITEM NO. Satin	SIZE(mm)	L(mm)	Satin Chrome Finished	
AAEW0606	6	104	10	320
AAEW0707	7	114	10	320
AAEW0808	8	124	10	320
AAEW0909	9	131	10	320
AAEW1010	10	143	10	320
AAEW1111	11	151	10	240
AAEW1212	12	160	10	120
AAEW1313	13	169	10	120
AAEW1414	14	180	10	120
AAEW1515	15	192	10	80
AAEW1616	16	198	10	80
AAEW1717	17	206	10	80
AAEW1818	18	214	10	80
AAEW1919	19	223	10	80
AAEW2020	20	236	10	80
AAEW2121	21	243	10	80
AAEW2222	22	255	5	40
AAEW2323	23	266	5	40
AAEW2424	24	274	5	40
AAEW2525	25	284	5	40
AAEW2626	26	294	5	30
AAEW2727	27	304	5	30
AAEW2828	28	315	5	30
AAEW2929	29	327	5	30
AAEW3030	30	340	5	30
AAEW3232	32	355	5	20

ITEM NO. Satin	SIZE(inch)	L(mm)	Satin Chrome Finished	
ACEW0808	1/4	104	10	320
ACEW1010	5/16	124	10	320
ACEW1111	11/32	131	10	320
ACEW1212	3/8	143	10	320
ACEW1414	7/16	151	10	240
ACEW1616	1/2	169	10	120
ACEW1818	9/16	180	10	120
ACEW2020	5/8	198	10	80
ACEW2222	11/16	206	10	80
ACEW2424	3/4	223	10	80
ACEW2626	13/16	236	10	80
ACEW2828	7/8	255	5	40
ACEW3030	15/16	274	5	40
ACEW3232	1	284	5	40
ACEW3434	1-1/16	304	5	30
ACEW3636	1-1/8	315	5	30
ACEW4040	1-1/4	355	5	20



ITEM NO. Satin	CONTENTS	Satin Chrome Finished (SET)
GPAW0801	10, 11, 12, 13, 14, 15, 17, 19	20
GPAW1202	12, 6, 7, 8, 10, 11, 12, 13, 14, 15, 17, 19, 22	10
GPAW1401	14, 8, 10, 11, 12, 13, 14, 15, 17, 19, 22, 24, 27, 30, 32	4
GPAW1402	14, 8, 9, 10, 11, 12, 13, 14, 15, 16, 17, 19, 21, 22, 24	10
GPAW1403	14, 6, 7, 8, 10, 12, 13, 14, 17, 19, 22, 24, 27, 30, 32	6
GPAW1601	16, 7, 8, 9, 10, 11, 12, 13, 14, 15, 17, 19, 22, 24, 27, 30, 32	4
GPBW1601	16 1/4", 5/16", 3/8", 7/16", 1/2", 9/16", 5/8", 11/16", 3/4", 13/16", 7/8", 15/16", 1", 1-1/16", 1-1/8", 1-1/4"	4
GPAW2601	26, 6, 7, 8, 9, 10, 11, 12, 13, 14, 15, 16, 17, 18, 19, 20, 21, 22, 23, 24, 25, 26, 27, 28, 29, 30, 32	3



**TOPTUL**  
YOUR BEST WORKING PARTNERS



**SUPER-TORQUE  
COMBINATION WRENCH**



- AAEQ SERIES -  
SUPER-TORQUE DYNAMIC COMBINATION WRENCH

**TOPTUL Dynamic / Ratchet-Effect Combination Wrench**

This special designed open end wrench allows the user to tighten or loosen the fastener without removing the wrench from the fastener to change position. The open end grabs the fastener when torque pressure is applied making it difficult to slip. Perfect for confined space applications.

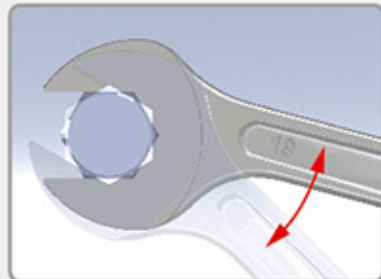
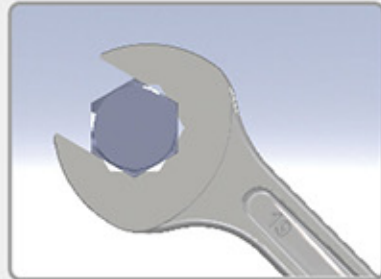

**Super-Torque Dynamic Combination Wrench 15° Offset**

- Chrome Vanadium Alloy Steel
- Robust construction design to work under extreme conditions
- High torque performance as over 1.6 times as ANSI & DIN standard
- Satin chrome finished for maximum durability and corrosion resistance



ITEM NO.	SIZE(mm)	L(mm)	Satin Chrome Finished	
			Hand	Box
AAEQ0808	8	124	10	320
AAEQ0909	9	131	10	320
AAEQ1010	10	143	10	320
AAEQ1111	11	151	10	240
AAEQ1212	12	160	10	120
AAEQ1313	13	169	10	120
AAEQ1414	14	180	10	120
AAEQ1515	15	192	10	80
AAEQ1616	16	198	10	80
AAEQ1717	17	206	10	80
AAEQ1818	18	214	10	80
AAEQ1919	19	223	10	80
AAEQ2020	20	236	10	80
AAEQ2121	21	243	10	80
AAEQ2222	22	255	5	40
AAEQ2323	23	266	5	40
AAEQ2424	24	274	5	40

**POUCH BAG - BLACK 14PCS**  
15° Offset Super-Torque Dynamic Combination Wrench Set



ITEM NO.	CONTENTS	Hand	Box
GPAQ1402	8, 9, 10, 11, 12, 13, 14, 15, 16, 17, 19, 21, 22, 24	10	10 (SET)

**Heavy Duty Wrenches Series**



**Slogging Ring Wrench 45° Offset**

- Chrome Vanadium Steel Material
- Manganese Phosphate Finished



ITEM NO.	SIZE(mm)	L(mm)	Black Phosphate Finished	
			Hand	Box
AAAU2424	24	250	3	12
AAAU2727	27	250	3	12
AAAU3030	30	270	3	12
AAAU3232	32	270	3	12
AAAU3636	36	300	2	8
AAAU3838	38	300	2	8
AAAU4141	41	317	2	8
AAAU4343	43	317	2	8
AAAU4646	46	360	2	4
AAAU5050	50	360	2	4
AAAU5555	55	360	2	4
AAAU6060	60	360	2	4
AAAU6565	65	380	2	4
AAAU7070	70	380	2	4
AAAU7575	75	415	1	2
AAAU8080	80	420	1	2
AAAU8585	85	450	1	2
AAAU9090	90	453	1	2
AAAU9595	95	500	1	2
AAAU0A00	100	505	1	2
AAAU5A55	105	520	1	2

**Single Ring Wrench 45° Offset**

- Chrome Vanadium Steel Material
- Manganese Phosphate Finished
- For use in combination with ALEA series handles



ITEM NO.	SIZE(mm)	L(mm)	Black Phosphate Finished	
			Hand	Box
AAAV2424	24	190	5	20
AAAV2727	27	190	5	20
AAAV3030	30	195	5	20
AAAV3232	32	195	5	20
AAAV3636	36	213	2	8
AAAV3838	38	213	2	8
AAAV4141	41	251	2	8
AAAV4343	43	251	2	8
AAAV4646	46	274	2	8
AAAV5050	50	274	2	8
AAAV5555	55	287	2	8
AAAV6060	60	300	2	8
AAAV6565	65	309	2	8
AAAV7070	70	309	2	8
AAAV7575	75	340	2	4
AAAV8080	80	340	2	4
AAAV8585	85	360	2	4
AAAV9090	90	360	2	4
AAAV9595	95	378	1	2
AAAVA0A0	100	378	1	2
AAAVA5A5	105	380	1	2

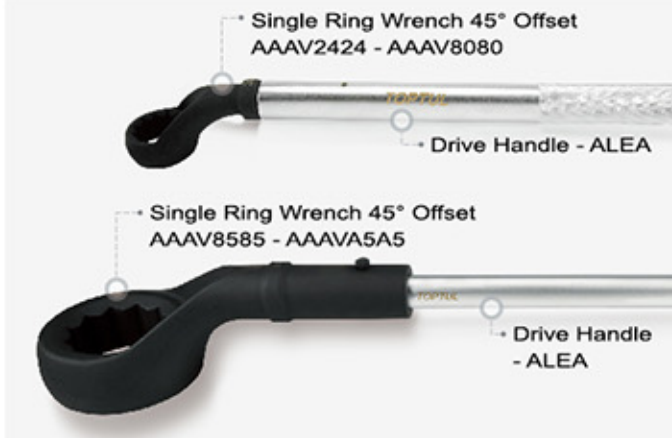

**Drive Handle**

- Chrome Vanadium Steel Material
- For use in combination with AAAV series wrenches



ITEM NO.	CAPACITY(mm)	L(mm)	Hand	Box
ALEA2430	24-30	350	5	20
ALEA3255	32-55	580	4	16
ALEA60A5	60-105	850	4	8

**- Heavy Duty Wrenches Series -**

- ▣ **Slogging Open End Wrench**  
• Chrome-Molybdenum Alloy Steel  
• Manganese Phosphate Finished



ITEM NO.	SIZE(mm)	L(mm)	Black Phosphate Finished	
			👤	👤
AAEY2424	24	168	5	60
AAEY2727	27	179	5	60
AAEY3030	30	189	5	40
AAEY3232	32	188	5	40
AAEY3636	36	213	4	24
AAEY3838	38	213	4	24
AAEY4141	41	234	2	12
AAEY4646	46	252	2	12
AAEY5050	50	272	2	12
AAEY5555	55	297	2	12
AAEY6060	60	316	2	8
AAEY6565	65	336	2	8
AAEY7070	70	367	1	2
AAEY7575	75	367	1	2
AAEY8080	80	398	1	2

- ▣ **Single Ring Wrench 45° Offset**  
• Chrome-Molybdenum Alloy Steel  
• Manganese Phosphate Finished



ITEM NO.	SIZE(mm)	L(mm)	Black Phosphate Finished	
			👤	👤
AAAS1717	17	324	5	30
AAAS1919	19	324	5	30
AAAS2121	21	368	5	20
AAAS2222	22	368	5	20
AAAS2323	23	368	5	20
AAAS2424	24	382	5	20
AAAS2626	26	382	5	20
AAAS2727	27	394	5	20
AAAS2929	29	394	5	20
AAAS3030	30	410	5	20
AAAS3232	32	410	5	20
AAAS3434	34	465	4	16
AAAS3535	35	465	4	16
AAAS3636	36	465	4	16
AAAS3838	38	490	3	12
AAAS4141	41	490	3	12
AAAS4343	43	519	3	12
AAAS4444	44	519	3	12
AAAS4646	46	519	3	12
AAAS4848	48	594	2	4
AAAS5050	50	594	2	4
AAAS5555	55	594	2	4
AAAS5858	58	616	1	2
AAAS6060	60	616	1	2
AAAS6565	65	616	1	2

- ▣ **Single Open End Wrench**  
• Chrome-Molybdenum Alloy Steel  
• Manganese Phosphate Finished



ITEM NO.	SIZE(mm)	L(mm)	Black Phosphate Finished	
			👤	👤
AAAT1616	16	161	10	160
AAAT1717	17	161	10	160
AAAT1818	18	161	10	160
AAAT1919	19	177	10	160
AAAT2020	20	177	10	160
AAAT2121	21	177	10	160
AAAT2222	22	197	6	96
AAAT2323	23	197	6	96
AAAT2424	24	197	6	96
AAAT2525	25	216	6	48
AAAT2626	26	216	6	48
AAAT2727	27	216	6	48
AAAT2828	28	243	6	48
AAAT2929	29	243	6	48
AAAT3030	30	243	6	48
AAAT3232	32	273	5	40
AAAT3333	33	273	5	40
AAAT3434	34	273	5	40
AAAT3535	35	299	5	30
AAAT3636	36	299	5	30
AAAT3838	38	299	5	30
AAAT4141	41	337	4	24
AAAT4242	42	337	4	24
AAAT4343	43	337	4	24
AAAT4444	44	374	3	18
AAAT4545	45	374	3	18
AAAT4646	46	374	3	18
AAAT4848	48	417	3	12
AAAT5050	50	417	3	12
AAAT5555	55	496	2	8
AAAT5858	58	496	2	8
AAAT6060	60	496	2	8

- ▣ **Slogging Ring Wrench**  
• Chrome-Molybdenum Alloy Steel  
• Manganese Phosphate Finished



ITEM NO.	SIZE(mm)	L(mm)	Black Phosphate Finished	
			👤	👤
AAAR2222	22	162	8	96
AAAR2323	23	162	8	96
AAAR2424	24	162	8	96
AAAR2525	25	162	8	96
AAAR2626	26	179	5	60
AAAR2727	27	179	5	60
AAAR2828	28	179	5	60
AAAR2929	29	189	5	60
AAAR3030	30	189	5	60
AAAR3232	32	189	5	60
AAAR3333	33	189	5	60
AAAR3434	34	204	4	32
AAAR3535	35	204	4	32
AAAR3636	36	204	4	32
AAAR3838	38	204	4	32
AAAR4040	40	229	3	24
AAAR4141	41	229	3	24
AAAR4242	42	229	3	24
AAAR4343	43	229	3	24
AAAR4444	44	240	2	16
AAAR4545	45	240	2	16
AAAR4646	46	240	2	16
AAAR4747	47	240	2	16
AAAR4848	48	253	2	16
AAAR5050	50	253	2	16
AAAR5252	52	253	2	16
AAAR5555	55	271	2	12
AAAR6060	60	281	2	12
AAAR6565	65	281	2	12
AAAR7070	70	335	1	6
AAAR7575	75	335	1	6
AAAR8080	80	365	1	4
AAAR8585	85	365	1	4
AAAR9090	90	400	1	2
AAAR9595	95	400	1	2
AAARA0A0	100	435	1	2
AAARA5A5	105	435	1	2



75 **Wrenches & Torque Wrenches**

▣ **Extra Long Combination Wrench 15° Offset**

- Chrome Vanadium Steel Material
- Extra long shank for reaching fasteners easily in deep space
- Professional quality for maximum durability and corrosion resistance



ITEM NO.	SIZE(mm)	L(mm)	⚙️	📦
AAAL1616	16	295	10	80

▣ **Extra Long Combination Wrench 15° Offset**

- Chrome Vanadium Steel Material
- Extra long shank for reaching fasteners easily in deep space
- Professional quality for maximum durability and corrosion resistance



ITEM NO.	SIZE(inch)	L(mm)	⚙️	📦
ACAL1212	3/8	187	10	120
ACAL1414	7/16	205	10	80
ACAL1616	1/2	241	10	80
ACAL1818	9/16	259	10	80
ACAL2020	5/8	295	10	80
ACAL2222	11/16	312	10	60
ACAL2424	3/4	347	10	60



**TOPTUL**  
EXTRA LONG  
COMBINATION WRENCH 15° OFFSET

▣ **Extra Long Combination Wrench 15° Offset**

- Chrome Vanadium Steel Material
- Extra long shank for reaching fasteners easily in deep space
- Professional quality for maximum durability and corrosion resistance



ITEM NO.	SIZE(mm)	L(mm)	⚙️	📦
AAEL1010	10	187	10	120
AAEL1111	11	205	10	80
AAEL1212	12	223	10	80
AAEL1313	13	241	10	80
AAEL1414	14	259	10	80
AAEL1515	15	277	10	80
AAEL1616	16	295	10	80
AAEL1717	17	312	10	60
AAEL1818	18	331	10	60
AAEL1919	19	347	10	60

▣ **TRAY 15° Offset Extra Long Combination Wrench Set** 10PCS



ITEM NO.	CONTENTS
GAAF1008	10, 11, 12, 13, 14, 15, 16, 17, 18, 19

▣ **STORAGE RACK 15° Offset Extra Long Combination Wrench Set** 7PCS



ITEM NO.	CONTENTS
GAAM0706	10, 11, 12, 13, 14, 17, 19

▣ **Long Combination Wrench 15° Offset**

- Chrome Vanadium Steel Material
- Long shank for extra torque with less operational strength requirement
- Professional quality for maximum durability and corrosion resistance



ITEM NO.	SIZE(mm)	L(mm)	⚙️	📦
AAAA0606	6	129	10	320
AAAA0707	7	136	10	320
AAAA0909	9	157	10	240
AAAA1616	16	241	10	80
AAAA1818	18	266	10	80
AAAA2020	20	278	10	80
AAAA2121	21	301	10	60
AAAA2323	23	335	5	30
AAAA2525	25	369	5	30
AAAA2626	26	369	5	30
AAAA2828	28	385	5	30
AAAA2929	29	402	5	30

▣ **Long Combination Wrench 15° Offset**

- Chrome Vanadium Steel Material
- Long shank for extra torque with less operational strength requirement
- Professional quality for maximum durability and corrosion resistance



ITEM NO.	SIZE(inch)	L(mm)	⚙️	📦
ACAA0808	1/4	129	10	320
ACAA1010	5/16	145	10	240
ACAA1111	11/32	157	10	240
ACAA1212	3/8	170	10	240
ACAA1414	7/16	182	10	120
ACAA1616	1/2	205	10	80
ACAA2222	11/16	254	10	80
ACAA2424	3/4	278	10	80
ACAA2626	13/16	301	10	60
ACAA2828	7/8	316	5	30
ACAA3232	1	369	5	30
ACAA3434	1-1/16	385	5	30
ACAA3636	1-1/8	402	5	30
ACAA4040	1-1/4	429	5	10



▣ **Long Combination Wrench 15° Offset**

- Chrome Vanadium Steel Material
- Long shank for extra torque with less operational strength requirement
- Professional quality for maximum durability and corrosion resistance



ITEM NO.	SIZE(mm)	L(mm)	⚙️	📦
AAEA0606	6	129	10	320
AAEA0707	7	136	10	320
AAEA0808	8	145	10	240
AAEA0909	9	157	10	240
AAEA1010	10	170	10	240
AAEA1111	11	182	10	120
AAEA1212	12	193	10	120
AAEA1313	13	205	10	80
AAEA1414	14	218	10	80
AAEA1515	15	230	10	80
AAEA1616	16	241	10	80
AAEA1717	17	254	10	80
AAEA1818	18	266	10	80
AAEA1919	19	278	10	80
AAEA2020	20	278	10	80
AAEA2121	21	301	10	60
AAEA2222	22	316	5	30
AAEA2323	23	335	5	30
AAEA2424	24	335	5	30
AAEA2525	25	369	5	30
AAEA2626	26	369	5	30
AAEA2727	27	385	5	30
AAEA2828	28	385	5	30
AAEA2929	29	402	5	30
AAEA3030	30	402	5	30
AAEA3232	32	429	5	10

▣ **Long Combination Wrench 15° Offset**

- Chrome Vanadium Steel Material
- Long shank for extra torque with less operational strength requirement
- Professional quality for maximum durability and corrosion resistance



ITEM NO.	SIZE(inch)	L(mm)	⚙️	📦
ACEA0808	1/4	129	10	320
ACEA1010	5/16	145	10	240
ACEA1111	11/32	157	10	240
ACEA1212	3/8	170	10	240
ACEA1414	7/16	182	10	120
ACEA1616	1/2	205	10	80
ACEA1818	9/16	218	10	80
ACEA2020	5/8	241	10	80
ACEA2222	11/16	254	10	80
ACEA2424	3/4	278	10	80
ACEA2626	13/16	301	10	60
ACEA2828	7/8	316	5	30
ACEA3030	15/16	335	5	30
ACEA3232	1	369	5	30
ACEA3434	1-1/16	385	5	30
ACEA3636	1-1/8	402	5	30
ACEA4040	1-1/4	429	5	10

77 **Wrenches & Torque Wrenches**

**POUCH BAG - GREEN**  
15° Offset Long Combination Wrench Set



GAAA0802



GAAA1215



GAAA1402

ITEM NO.	CONTENTS	(SET)	ITEM NO.	CONTENTS	(SET)
GAAA0802	10, 11, 12, 13, 14, 15, 17, 19	10	GAAA1410	8, 9, 10, 11, 12, 13, 14, 15, 16, 17, 19, 21, 22, 24	6
GAAA1215	6, 7, 8, 10, 11, 12, 13, 14, 15, 17, 19, 22	6	GAAA1602	7, 8, 9, 10, 11, 12, 13, 14, 15, 17, 19, 22, 24, 27, 30, 32	4
GAAA1402	8, 10, 11, 12, 13, 14, 15, 17, 19, 22, 24, 27, 30, 32	4	GAAA2602	6, 7, 8, 9, 10, 11, 12, 13, 14, 15, 16, 17, 18, 19, 20, 21, 22, 23, 24, 25, 26, 27, 28, 29, 30, 32	3



GAAA1410



GAAA1602



GAAA2602

**POUCH BAG - GREEN**  
15° Offset Long Combination Wrench Set

★ 16PCS



ITEM NO.	CONTENTS	(SET)
GBAA1601	1/4", 5/16", 3/8", 7/16", 1/2", 9/16", 5/8", 11/16", 3/4", 13/16", 7/8", 15/16", 1", 1-1/16", 1-1/8", 1-1/4"	4 (SET)

**POUCH BAG - BLACK**  
15° Offset Long Combination Wrench Set



GPAA0802



GPAA1204

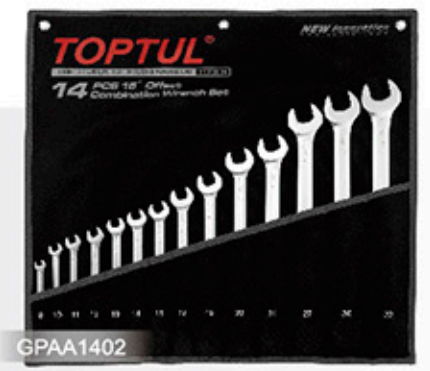

GPAA1402

ITEM NO.	CONTENTS	(SET)	ITEM NO.	CONTENTS	(SET)
GPAA0802	10, 11, 12, 13, 14, 15, 17, 19	10	GPAA1404	8, 9, 10, 11, 12, 13, 14, 15, 16, 17, 19, 21, 22, 24	6
GPAA1204	6, 7, 8, 10, 11, 12, 13, 14, 15, 17, 19, 22	6	GPAA1602	7, 8, 9, 10, 11, 12, 13, 14, 15, 17, 19, 22, 24, 27, 30, 32	4
GPAA1402	8, 10, 11, 12, 13, 14, 15, 17, 19, 22, 24, 27, 30, 32	4	GPAA2602	6, 7, 8, 9, 10, 11, 12, 13, 14, 15, 16, 17, 18, 19, 20, 21, 22, 23, 24, 25, 26, 27, 28, 29, 30, 32	3

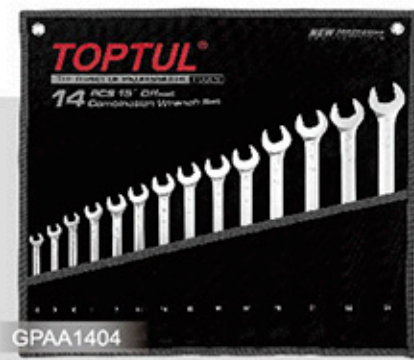

GPAA1404



GPAA1602



GPAA2602

**POUCH BAG - BLACK**  
15° Offset Long Combination Wrench Set

★



GPAA1201



GPAA1401



GPAA1601

ITEM NO.	CONTENTS	(SET)	ITEM NO.	CONTENTS	(SET)
GPAA1201	7, 8, 10, 11, 12, 13, 16, 17, 18, 19, 22, 24	6	GPAA1601	7, 8, 9, 10, 11, 12, 13, 14, 15, 17, 19, 22, 24, 27, 30, 32	4
GPAA1401	8, 10, 11, 12, 13, 14, 15, 17, 19, 22, 24, 27, 30, 32	4			

79 **Wrenches & Torque Wrenches**

Pro-Line Combination Wrench 15° Offset



**-AAB SERIES-  
STANDARD COMBINATION WRENCH**  
FOR GENERAL INDUSTRIAL APPLICATIONS  
(Professional model for quick tightening & loosening application)

**-AABW SERIES-  
PRO-LINE COMBINATION WRENCH**  
FOR AUTOMOTIVE REPAIR & MAINTENANCE  
(Strong and perfect weight ratio model for best performance and maximize jobs)

Pro-Line Combination Wrench 15° Offset

- Chrome Vanadium Alloy Steel
- Thin profile head and ring for easy access in confined spaces
- Light weight model
- High torque performance as over 1.6 times as ANSI & DIN standard
- Satin chrome finished for maximum durability and corrosion resistance



**More Efficient Open-End Design**  
The design of the bending open-end aligns with center line of the handle in angle 15 degrees. Rotate bending open-end oppositely to increase work area in confined space for tightening and loosening applications.

**Extra Comfort & Effective Grip**  
Larger side handle to maximize the contact comfort and enhance grip power with the hand.



**Better Ring Head Accessibility**  
Specially designed ring head provides better clearance for reaching recessed spaced nuts.



**Protuberant Character Design**  
The visible and notable stamping characters provides easy reading before use.



ITEM NO.	SIZE(mm)	L(mm)	Satin Chrome Finished	
Satin			📦 (SET)	📦 (SET)
AABW0606	6	104	10	320
AABW0707	7	114	10	320
AABW0808	8	124	10	320
AABW0909	9	131	10	320
AABW1010	10	143	10	320
AABW1111	11	151	10	240
AABW1212	12	160	10	120
AABW1313	13	169	10	120
AABW1414	14	180	10	120
AABW1515	15	192	10	80
AABW1616	16	198	10	80
AABW1717	17	206	10	80
AABW1818	18	214	10	80
AABW1919	19	223	10	80
AABW2020	20	236	10	80
AABW2121	21	243	10	80
AABW2222	22	255	5	40
AABW2323	23	266	5	40
AABW2424	24	274	5	40
AABW2525	25	284	5	40
AABW2626	26	294	5	30
AABW2727	27	304	5	30
AABW2828	28	315	5	30
AABW2929	29	327	5	30
AABW3030	30	340	5	30
AABW3232	32	355	5	20

**PRO-LINE COMBINATION WRENCH**

POUCH BAG - BLACK  
15° Offset Pro-Line Combination Wrench Set



ITEM NO.	CONTENTS	Satin Chrome Finished
Satin		📦 (SET)
GPCW0801	8, 10, 12, 13, 14, 17, 19, 22	10



ITEM NO.	CONTENTS	Satin Chrome Finished
Satin		📦 (SET)
GPCW1401	8, 9, 10, 11, 12, 13, 14, 15, 16, 17, 19, 21, 22, 24	10

POUCH BAG - GREEN  
15° Offset Pro-Line Combination Wrench Set



GRAW0801



GRAW1001



GRAW1601

ITEM NO.	CONTENTS	Satin Chrome Finished
Satin		📦 (SET)
GRAW0801	8, 10, 12, 13, 14, 17, 19, 22	10
GRAW1001	8, 10, 11, 12, 13, 14, 17, 19, 22, 24	10

ITEM NO.	CONTENTS	Satin Chrome Finished
Satin		📦 (SET)
GRAW1401	8, 9, 10, 11, 12, 13, 14, 15, 16, 17, 19, 21, 22, 24	10
GRAW1601	6, 7, 8, 9, 10, 11, 12, 13, 14, 15, 16, 17, 18, 19, 22, 24	6

METAL BOX  
15° Offset Pro-Line Combination Wrench Set



ITEM NO.	CONTENTS	Satin Chrome Finished
Satin		📦 3 (SET)
GAAD1604	6, 7, 8, 9, 10, 11, 12, 13, 14, 15, 16, 17, 18, 19, 22, 24	

METAL CASE: W445 x D188 x H50 (mm)

81 **Wrenches & Torque Wrenches**

- **Standard Combination Wrench 15° Offset**
- Chrome Vanadium Steel Material
  - High torque performance as over 1.6 times as ANSI & DIN standard
  - Professional quality for maximum durability and corrosion resistance

- ★ ■ **Standard Combination Wrench 15° Offset**
- Chrome Vanadium Steel Material
  - High torque performance as over 1.6 times as ANSI & DIN standard
  - Professional quality for maximum durability and corrosion resistance



ITEM NO.	SIZE(mm)	L(mm)	Mirror Polished	
			Hand	Box
AAAB0707	7	119	10	320
AAAB0808	8	129	10	320
AAAB0909	9	139	10	320
AAAB1010	10	149	10	320
AAAB1111	11	159	10	240
AAAB1212	12	169	10	120
AAAB1313	13	179	10	120
AAAB1414	14	189	10	120
AAAB1515	15	199	10	80
AAAB1616	16	209	10	80
AAAB1717	17	219	10	80
AAAB1919	19	239	10	80
AAAB2020	20	249	10	80
AAAB2121	21	259	10	80
AAAB2222	22	269	5	40
AAAB2323	23	279	5	40
AAAB2424	24	289	5	40
AAAB2525	25	299	5	40
AAAB2626	26	309	5	30
AAAB2727	27	319	5	30
AAAB2828	28	329	5	30
AAAB2929	29	339	5	30
AAAB3030	30	349	5	30
AAAB3232	32	369	5	20
AAAB3333	33	409	5	20
AAAB3434	34	409	5	20
AAAB3535	35	409	5	20

ITEM NO.	SIZE(mm)	L(mm)	Satin Chrome Finished	
			Hand	Box
AAEB0606	6	109	10	320
AAEB0707	7	119	10	320
AAEB0808	8	129	10	320
AAEB0909	9	139	10	320
AAEB1010	10	149	10	320
AAEB1111	11	159	10	240
AAEB1212	12	169	10	120
AAEB1313	13	179	10	120
AAEB1414	14	189	10	120
AAEB1515	15	199	10	80
AAEB1616	16	209	10	80
AAEB1717	17	219	10	80
AAEB1818	18	229	10	80
AAEB1919	19	239	10	80
AAEB2020	20	249	10	80
AAEB2121	21	259	10	80
AAEB2222	22	269	5	40
AAEB2323	23	279	5	40
AAEB2424	24	289	5	40
AAEB2525	25	299	5	40
AAEB2626	26	309	5	30
AAEB2727	27	319	5	30
AAEB2828	28	329	5	30
AAEB2929	29	339	5	30
AAEB3030	30	349	5	30
AAEB3232	32	369	5	20
AAEB3333	33	409	5	20
AAEB3434	34	409	5	20
AAEB3535	35	409	5	20
AAEB3636	36	439	5	10
AAEB3838	38	439	5	10
AAEB4040	40	479	2	8
AAEB4141	41	479	2	8
AAEB4242	42	479	2	8
AAEB4343	43	479	2	8

- **Standard Combination Wrench 15° Offset (Jumbo)**
- Chrome Vanadium Steel Material
  - High torque performance as over 1.6 times as ANSI & DIN standard
  - Professional quality for maximum durability and corrosion resistance



ITEM NO.	SIZE(mm)	L(mm)	Satin Chrome Finished	
			Hand	Box
AAEB4545	45	549	2	4
AAEB4646	46	549	2	4
AAEB4848	48	549	2	4
AAEB5050	50	549	2	4
AAEB5555	55	609	2	4
AAEB6060	60	699	1	2
AAEB6565	65	699	1	2
AAEB7070	70	680	1	2
AAEB7575	75	720	1	2
AAEB8080	80	720	1	2



- **Standard Combination Wrench 15° Offset**
- Chrome Vanadium Steel Material
  - High torque performance as over 1.6 times as ANSI & DIN standard
  - Professional quality for maximum durability and corrosion resistance

- ★ ■ **Standard Combination Wrench 15° Offset**
- Chrome Vanadium Steel Material
  - High torque performance as over 1.6 times as ANSI & DIN standard
  - Professional quality for maximum durability and corrosion resistance



ITEM NO.	SIZE(inch)	L(mm)	Mirror Polished	
			Hand	Box
ACAB0808	1/4	109	10	320
ACAB1010	5/16	129	10	320
ACAB1414	7/16	159	10	240
ACAB2020	5/8	209	10	80
ACAB2222	11/16	219	10	80
ACAB2424	3/4	239	10	80
ACAB2626	13/16	259	10	80
ACAB2828	7/8	269	5	40
ACAB3232	1	299	5	40
ACAB3636	1-1/8	339	5	30
ACAB4040	1-1/4	369	5	20



ITEM NO.	SIZE(inch)	L(mm)	Satin Chrome Finished	
			Hand	Box
ACEB0808	1/4	109	10	320
ACEB1010	5/16	129	10	320
ACEB1111	11/32	139	10	320
ACEB1212	3/8	149	10	320
ACEB1414	7/16	159	10	240
ACEB1616	1/2	179	10	120
ACEB1818	9/16	189	10	120
ACEB2020	5/8	209	10	80
ACEB2222	11/16	219	10	80
ACEB2424	3/4	239	10	80
ACEB2626	13/16	259	10	80
ACEB2828	7/8	269	5	40
ACEB3030	15/16	289	5	40
ACEB3232	1	299	5	40
ACEB3434	1-1/16	319	5	30
ACEB3636	1-1/8	339	5	30
ACEB4040	1-1/4	369	5	20
ACEB4242	1-5/16	409	5	20
ACEB4444	1-3/8	409	5	20
ACEB4646	1-7/16	439	5	10
ACEB4848	1-1/2	439	5	10
ACEB5252	1-5/8	479	2	8
ACEB5454	1-11/16	479	2	8
ACEB5656	1-3/4	549	2	4
ACEB5858	1-13/16	549	2	4
ACEB6060	1-7/8	549	2	4
ACEB6464	2	549	2	4
ACEB6868	2-1/8	609	2	4
ACEB7070	2-3/16	609	2	4
ACEB7272	2-1/4	609	2	4
ACEB7676	2-3/8	699	1	2
ACEB8080	2-1/2	699	1	2

- **STORAGE RACK** 11PCS
- 15° Offset Standard Combination Wrench Set



ITEM NO.	CONTENTS	Satin Chrome Finished
GAAC1103	8, 10, 11, 12, 13, 14, 15, 16, 17, 18, 19	5 (SET)

- **COLOR BOX** 12PCS
- 15° Offset Standard Combination Wrench Set



ITEM NO.	CONTENTS	Mirror / Satin Chrome Finished
GAAE1210	6, 7, 8, 9, 10, 11, 12, 13, 14, 15, 17, 19	10 (SET)
GAAE1211	6, 7, 8, 9, 10, 11, 12, 13, 14, 15, 17, 19	10 (SET)

- **METAL BOX** 16PCS
- 15° Offset Standard Combination Wrench Set



ITEM NO.	CONTENTS	Satin Chrome Finished
GAAD1602	6, 7, 8, 9, 10, 11, 12, 13, 14, 15, 16, 17, 18, 19, 22, 24	3 (SET)

METAL CASE: W445 x D188 x H50 (mm)



83 **Wrenches & Torque Wrenches**

POUCH BAG - BLACK  
15° Offset Standard Combination Wrench Set



ITEM NO.	CONTENTS	Satin Chrome Finished (SET)	ITEM NO.	CONTENTS	Satin Chrome Finished (SET)
GPAB0802	10, 11, 12, 13, 14, 15, 17, 19	20	GPAB1406	6, 7, 8, 10, 12, 13, 14, 17, 19, 22, 24, 27, 30, 32	6
GPAB1204	6, 7, 8, 10, 11, 12, 13, 14, 15, 17, 19, 22	10	GPAB1602	6, 7, 8, 9, 10, 11, 12, 13, 14, 15, 17, 19, 22, 24, 27, 30, 32	4
GPAB1402	6, 7, 8, 9, 10, 11, 12, 13, 14, 15, 17, 19, 22, 24, 27, 30, 32	4	GPAB2602	6, 7, 8, 9, 10, 11, 12, 13, 14, 15, 16, 17, 18, 19, 20, 21, 22, 23, 24, 25, 26, 27, 28, 29, 30, 32	3
GPAB1404	6, 7, 8, 9, 10, 11, 12, 13, 14, 15, 16, 17, 19, 21, 22, 24	10			



POUCH BAG - GREEN  
15° Offset Standard Combination Wrench Set



ITEM NO.	CONTENTS	Satin Chrome Finished (SET)	ITEM NO.	CONTENTS	Satin Chrome Finished (SET)
GAAA0804	10, 11, 12, 13, 14, 15, 17, 19	20	GAAA1408	6, 7, 8, 9, 10, 11, 12, 13, 14, 15, 16, 17, 19, 21, 22, 24	10
GAAA1213	6, 7, 8, 10, 11, 12, 13, 14, 15, 17, 19, 22	10	GAAA1604	6, 7, 8, 9, 10, 11, 12, 13, 14, 15, 17, 19, 22, 24, 27, 30, 32	4
GAAA1404	6, 7, 8, 9, 10, 11, 12, 13, 14, 15, 17, 19, 22, 24, 27, 30, 32	4	GAAA2604	6, 7, 8, 9, 10, 11, 12, 13, 14, 15, 16, 17, 18, 19, 20, 21, 22, 23, 24, 25, 26, 27, 28, 29, 30, 32	3



POUCH BAG - BLACK  
15° Offset Standard Combination Wrench Set

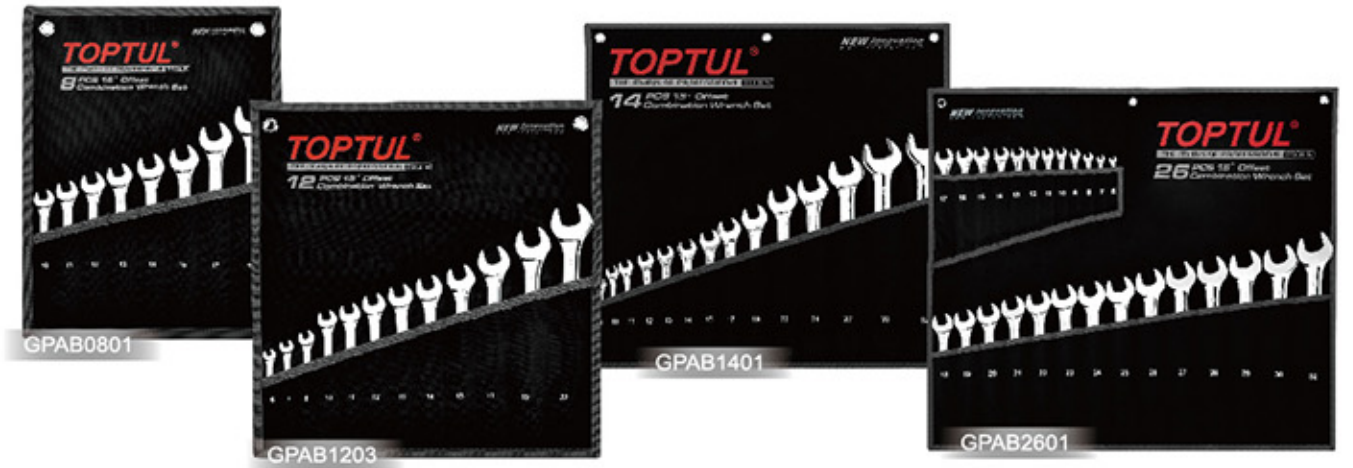

ITEM NO.	CONTENTS	Mirror Polished (SET)	ITEM NO.	CONTENTS	Mirror Polished (SET)
GPAB0801	10, 11, 12, 13, 14, 15, 17, 19	20	GPAB1401	6, 7, 8, 9, 10, 11, 12, 13, 14, 15, 17, 19, 22, 24, 27, 30, 32	4
GPAB1203	6, 7, 8, 10, 11, 12, 13, 14, 15, 17, 19, 22	10			

POUCH BAG - GREEN  
15° Offset Standard Combination Wrench Set



ITEM NO.	CONTENTS	Mirror Polished (SET)
GAAA1212	6, 7, 8, 10, 11, 12, 13, 14, 15, 17, 19, 22	10

POUCH BAG - GREEN  
15° Offset Standard Combination Wrench Set



ITEM NO.	CONTENTS	Mirror Polished (SET)
GAAA0803	10, 11, 12, 13, 14, 15, 17, 19	20

POUCH BAG - BLACK  
15° Offset Standard Combination Wrench Set



ITEM NO.	CONTENTS	Satin Chrome Finished (SET)
GPBB1602	1/4", 5/16", 3/8", 7/16", 1/2", 9/16", 5/8", 11/16", 3/4", 13/16", 7/8", 15/16", 1", 1-1/16", 1-1/8", 1-1/4"	4 (SET)

POUCH BAG - GREEN  
15° Offset Standard Combination Wrench Set



ITEM NO.	CONTENTS	Mirror / Satin Chrome Finished (SET)
GBAA1603	1/4", 5/16", 3/8", 7/16", 1/2", 9/16", 5/8", 11/16", 3/4", 13/16", 7/8", 15/16", 1", 1-1/16", 1-1/8", 1-1/4"	4 (SET)

85 **Wrenches & Torque Wrenches**

Standard Combination Wrench 75° Offset

- Chrome Vanadium Steel Material
- Professional quality for maximum durability and corrosion resistance
- 75° offset ring end in design for operating easily in recess

Standard Combination Wrench 75° Offset

- Chrome Vanadium Steel Material
- Professional quality for maximum durability and corrosion resistance
- 75° offset ring end in design for operating easily in recess



ITEM NO.	SIZE(mm)	L(mm)	Mirror Polished
AAAN0909	9	140	10 320
AAAN2222	22	285	5 40
AAAN2323	23	315	5 30
AAAN2424	24	315	5 30
AAAN2525	25	345	5 30
AAAN2626	26	345	5 30
AAAN2727	27	365	2 12
AAAN2828	28	365	2 12
AAAN2929	29	395	2 12
AAAN3030	30	395	2 12
AAAN3232	32	415	2 12

ITEM NO.	SIZE(Inch)	L(mm)	Mirror Polished
ACAN4040	1-1/4	415	2 12

Standard Combination Wrench 75° Offset

- Chrome Vanadium Steel Material
- Professional quality for maximum durability and corrosion resistance
- 75° offset ring end in design for operating easily in recess

Standard Combination Wrench 75° Offset

- Chrome Vanadium Steel Material
- Professional quality for maximum durability and corrosion resistance
- 75° offset ring end in design for operating easily in recess



ITEM NO.	SIZE(mm)	L(mm)	Satin Chrome Finished
AAEN0606	6	110	10 320
AAEN0707	7	120	10 320
AAEN0808	8	130	10 320
AAEN0909	9	140	10 320
AAEN1010	10	150	10 160
AAEN1111	11	160	10 240
AAEN1212	12	170	10 160
AAEN1313	13	180	10 120
AAEN1414	14	190	10 120
AAEN1515	15	205	10 80
AAEN1616	16	215	10 80
AAEN1717	17	225	10 80
AAEN1818	18	235	10 80
AAEN1919	19	255	5 40
AAEN2020	20	255	5 40
AAEN2121	21	285	5 40
AAEN2222	22	285	5 40
AAEN2323	23	315	5 30
AAEN2424	24	315	5 30
AAEN2525	25	345	5 30
AAEN2626	26	345	5 30
AAEN2727	27	365	2 12
AAEN2828	28	365	2 12
AAEN2929	29	395	2 12
AAEN3030	30	395	2 12
AAEN3232	32	415	2 12

ITEM NO.	SIZE(Inch)	L(mm)	Satin Chrome Finished
ACEN0808	1/4	110	10 320
ACEN1010	5/16	130	10 320
ACEN1212	3/8	150	10 160
ACEN1414	7/16	160	10 240
ACEN1818	9/16	190	10 120
ACEN2020	5/8	215	10 80
ACEN2222	11/16	225	10 80
ACEN2424	3/4	255	5 40
ACEN2626	13/16	285	5 40
ACEN2828	7/8	285	5 40
ACEN3030	15/16	315	5 30
ACEN3232	1	345	5 30
ACEN3434	1-1/16	365	2 12
ACEN3636	1-1/8	395	2 12
ACEN4040	1-1/4	415	2 12

POUCH BAG - BLACK 12PCS  
75° Offset Standard Combination Wrench Set

COLOR BOX 8PCS  
75° Offset Standard Combination Wrench Set

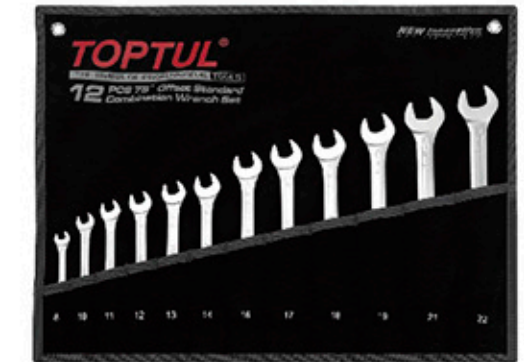

ITEM NO.	CONTENTS	Satin Chrome Finished
GAAE0811	8, 10, 12, 13, 14, 17, 19, 22	10 (SET)

ITEM NO.	CONTENTS	Satin Chrome Finished
GPAN1201	8, 10, 11, 12, 13, 14, 16, 17, 18, 19, 21, 22	6 (SET)

CR-V Steel  
Satin Chrome Finish  
Industrial DIN Standard

With 75° offset in design, this wrench will overcome the operational restriction compared with the traditional type combination wrench

Robust construction & Precision machining  
Maximum tool torque and durability

**STANDARD COMBINATION WRENCH 75° OFFSET**



**TOPTUL**  
STANDARD COMBINATION WRENCH 75° OFFSET

87 Wrenches & Torque Wrenches

Double Open End Wrench



**TOPTUL**  
DOUBLE OPEN END WRENCH

Double Open End Wrench

- Chrome Vanadium Steel Material
- Professional quality for maximum durability and corrosion resistance



• METRIC

Double Open End Wrench

- Chrome Vanadium Steel Material
- Professional quality for maximum durability and corrosion resistance



• SAE

ITEM NO.	SIZE(mm)	L(mm)	Mirror Polished	
			👤	📦
AAAJE507	5.5x7	127	10	320
AAAJ0607	6x7	127	10	320
AAAJ0810	8x10	145	10	320
AAAJ0911	9x11	161	10	240
AAAJ1012	10x12	161	10	240
AAAJ1013	10x13	174	10	120
AAAJ1113	11x13	174	10	120
AAAJ1214	12x14	174	10	120
AAAJ1315	13x15	190	10	120
AAAJ1317	13x17	194	10	120
AAAJ1417	14x17	194	10	120
AAAJ1719	17x19	223	10	80
AAAJ1921	19x21	236	10	80
AAAJ2022	20x22	236	10	80
AAAJ2123	21x23	246	10	60
AAAJ2326	23x26	267	5	40
AAAJ2528	25x28	267	5	40
AAAJ2627	26x27	267	5	40
AAAJ2732	27x32	294	5	40
AAAJ3538	35x38	377	2	12

ITEM NO.	SIZE(inch)	L(mm)	Mirror Polished	
			👤	📦
ACAJ0810	1/4x5/16	127	10	320
ACAJ1012	5/16x3/8	145	10	320
ACAJ1820	9/16x5/8	190	10	120
ACAJ1822	9/16x11/16	194	10	120
ACAJ2224	11/16x3/4	223	10	80
ACAJ2428	3/4x7/8	236	10	80
ACAJ2628	13/16x7/8	236	10	80
ACAJ3032	15/16x1	267	5	40
ACAJ3236	1x1-1/8	267	5	40
ACAJ3436	1-1/16x1-1/8	284	5	40
ACAJ3440	1-1/16x1-1/4	294	5	40
ACAJ3842	1-3/16x1-5/16	294	5	40
ACAJ4652	1-7/16x1-5/8	377	2	12

Double Open End Wrench

- Chrome Vanadium Steel Material
- Professional quality for maximum durability and corrosion resistance



• METRIC

ITEM NO.	SIZE(mm)	L(mm)	Satin Chrome Finished	
			👤	📦
AAEJ0405	4x5	99	10	320
AAEJE507	5.5x7	127	10	320
AAEJ0607	6x7	127	10	320
AAEJ0809	8x9	145	10	320
AAEJ0810	8x10	145	10	320
AAEJ0911	9x11	161	10	240
AAEJ1011	10x11	161	10	240
AAEJ1012	10x12	161	10	240
AAEJ1013	10x13	174	10	120
AAEJ1113	11x13	174	10	120
AAEJ1213	12x13	174	10	120
AAEJ1214	12x14	174	10	120
AAEJ1314	13x14	190	10	120
AAEJ1315	13x15	190	10	120
AAEJ1415	14x15	190	10	120
AAEJ1317	13x17	194	10	120
AAEJ1417	14x17	194	10	120
AAEJ1617	16x17	210	10	80
AAEJ1618	16x18	210	10	80
AAEJ1719	17x19	223	10	80
AAEJ1819	18x19	223	10	80
AAEJ1921	19x21	236	10	80
AAEJ1922	19x22	236	10	80
AAEJ2021	20x21	236	10	80
AAEJ2022	20x22	236	10	80
AAEJ2123	21x23	246	10	60
AAEJ2224	22x24	246	10	60
AAEJ2426	24x26	267	5	40
AAEJ2427	24x27	267	5	40
AAEJ2528	25x28	267	5	40
AAEJ2628	26x28	267	5	40
AAEJ2729	27x29	284	5	40
AAEJ2730	27x30	284	5	40
AAEJ2732	27x32	294	5	40
AAEJ3032	30x32	294	5	40
AAEJ3235	32x35	325	2	12
AAEJ3236	32x36	325	2	12
AAEJ3335	33x35	325	2	12
AAEJ3436	34x36	325	2	12
AAEJ3538	35x38	377	2	12
AAEJ3641	36x41	377	2	12
AAEJ3842	38x42	377	2	12
AAEJ4146	41x46	426	2	12
AAEJ4650	46x50	477	2	10
AAEJ5055	50x55	504	2	8
AAEJ5560	55x60	504	2	8

Double Open End Wrench

- Chrome Vanadium Steel Material
- Professional quality for maximum durability and corrosion resistance



• SAE

ITEM NO.	SIZE(inch)	L(mm)	Satin Chrome Finished	
			👤	📦
ACEJ0810	1/4x5/16	127	10	320
ACEJ1012	5/16x3/8	145	10	320
ACEJ1214	3/8x7/16	161	10	240
ACEJ1416	7/16x1/2	174	10	120
ACEJ1618	1/2x9/16	174	10	120
ACEJ1822	9/16x11/16	194	10	120
ACEJ1922	19/32x11/16	194	10	120
ACEJ2022	5/8x11/16	210	10	80
ACEJ2224	11/16x3/4	223	10	80
ACEJ2426	3/4x13/16	236	10	80
ACEJ2628	13/16x7/8	236	10	80
ACEJ2830	7/8x15/16	246	10	60
ACEJ3234	1x1-1/16	267	5	40
ACEJ3640	1-1/8x1-1/4	294	5	40
ACEJ3842	1-3/16x1-5/16	294	5	40

POUCH BAG - GREEN

Double Open End Wrench Set

8PCS

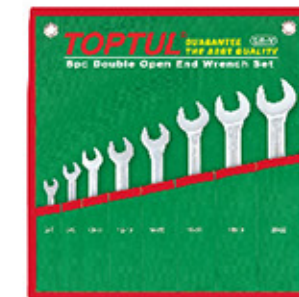

ITEM NO.	CONTENTS	Satin Chrome Finished
GAAA0812	6x7, 8x9, 10x11, 12x13, 14x15, 16x17, 18x19, 20x22	👤 20 (SET)

POUCH BAG - GREEN

Double Open End Wrench Set

12PCS



ITEM NO.	CONTENTS	Mirror / Satin Chrome Finished
GAAA1205	6x7, 8x9, 10x11, 12x13, 14x15, 16x17, 18x19, 20x22, 21x23	👤 6 (SET)
GAAA1206	24x27, 25x28, 30x32	

**TOPTUL**  
YOUR BEST WORKING PARTNERS

89 **Wrenches & Torque Wrenches**

**POUCH BAG - BLACK**  
Double Open End Wrench Set

10PCS



ITEM NO.	CONTENTS	Finish	Quantity
Satin		Satin Chrome Finished	10 (SET)
GPCJ1001	6x7, 8x9, 10x11, 12x13, 14x15, 16x17, 18x19, 20x22, 24x27, 30x32		

**DOUBLE OPEN END WRENCH SET**

**POUCH BAG - BLACK**  
Double Open End Wrench Set

8PCS

**STORAGE RACK**  
Double Open End Wrench Set

8PCS



ITEM NO.	CONTENTS	Finish	Quantity
Satin		Satin Chrome Finished	20 (SET)
GPAJ0802	6x7, 8x9, 10x11, 12x13, 14x15, 16x17, 18x19, 20x22		

ITEM NO.	CONTENTS	Finish	Quantity
Satin		Satin Chrome Finished	5 (SET)
GAAC0802	6x7, 8x9, 10x11, 12x13, 14x15, 16x17, 18x19, 20x22		

**POUCH BAG - BLACK**  
Double Open End Wrench Set

12PCS

**METAL BOX**  
Double Open End Wrench Set

10PCS



ITEM NO.	CONTENTS	Finish	Quantity
Satin		Satin Chrome Finished	6 (SET)
GPAJ1202	6x7, 8x9, 10x11, 12x13, 14x15, 16x17, 18x19, 20x22, 21x23, 24x27, 25x28, 30x32		

ITEM NO.	CONTENTS	Finish	Quantity
Satin		Satin Chrome Finished	6 (SET)
GAAD1009	6x7, 8x9, 10x11, 12x13, 14x15, 16x17, 18x19, 20x22, 21x23, 24x27		

METAL CASE: W370 x D154 x H50 (mm)

**Double Ring Wrench 75° Offset**

With 75° offset ring end design, this wrench can overcome the operating restriction compared to those conventional combination wrenches.

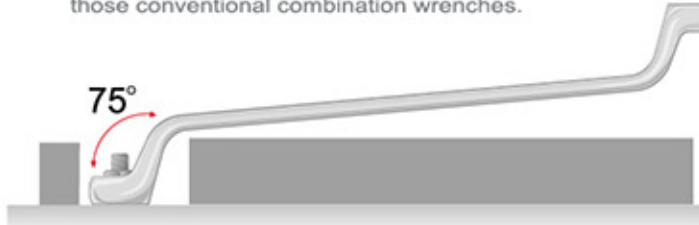

**Double Ring Wrench 75° Offset**

- Chrome Vanadium Steel Material
- 75° offset ring end in design for convenient operation in recess
- High torque performance as over 1.6 times as ANSI & DIN standard



METRIC	ITEM NO.	SIZE(mm)	L(mm)	Finish	Quantity
Mirror	AAAE507	5.5x7	167	Mirror Polished	240
Mirror	AAAI0608	6x8	172	Mirror Polished	120
Mirror	AAAI0708	7x8	172	Mirror Polished	120
Mirror	AAAI0809	8x9	182	Mirror Polished	120
Mirror	AAAI0810	8x10	182	Mirror Polished	120
Mirror	AAAI1013	10x13	217	Mirror Polished	80
Mirror	AAAI1113	11x13	217	Mirror Polished	80
Mirror	AAAI1213	12x13	218	Mirror Polished	80
Mirror	AAAI1315	13x15	238	Mirror Polished	80
Mirror	AAAI1415	14x15	238	Mirror Polished	80
Mirror	AAAI1316	13x16	245	Mirror Polished	80
Mirror	AAAI1417	14x17	245	Mirror Polished	80
Mirror	AAAI1617	16x17	258	Mirror Polished	40
Mirror	AAAI1819	18x19	290	Mirror Polished	40
Mirror	AAAI1821	18x21	296	Mirror Polished	40
Mirror	AAAI2022	20x22	316	Mirror Polished	30
Mirror	AAAI2123	21x23	316	Mirror Polished	30
Mirror	AAAI2224	22x24	324	Mirror Polished	30
Mirror	AAAI2426	24x26	328	Mirror Polished	30
Mirror	AAAI2528	25x28	345	Mirror Polished	30
Mirror	AAAI2732	27x32	353	Mirror Polished	12

**Double Ring Wrench 75° Offset**

- Chrome Vanadium Steel Material
- 75° offset ring end in design for convenient operation in recess
- High torque performance as over 1.6 times as ANSI & DIN standard



SAE	ITEM NO.	SIZE(inch)	L(mm)	Finish	Quantity
Mirror	ACAI1416	7/16x1/2	217	Mirror Polished	80
Mirror	ACAI1618	1/2x9/16	238	Mirror Polished	80
Mirror	ACAI1820	9/16x5/8	238	Mirror Polished	80
Mirror	ACAI2022	5/8x11/16	258	Mirror Polished	40
Mirror	ACAI2224	11/16x3/4	290	Mirror Polished	40
Mirror	ACAI2426	3/4x13/16	296	Mirror Polished	30
Mirror	ACAI3032	15/16x1	328	Mirror Polished	30
Mirror	ACAI3640	1-1/8x1-1/4	360	Mirror Polished	12

**Double Ring Wrench 75° Offset**

- Chrome Vanadium Steel Material
- 75° offset ring end in design for convenient operation in recess
- High torque performance as over 1.6 times as ANSI & DIN standard



METRIC	ITEM NO.	SIZE(mm)	L(mm)	Finish	Quantity
Satin	AAEI507	5.5x7	167	Satin Chrome Finished	10
Satin	AAEI0607	6x7	167	Satin Chrome Finished	10
Satin	AAEI0608	6x8	172	Satin Chrome Finished	10
Satin	AAEI0708	7x8	172	Satin Chrome Finished	10
Satin	AAEI0809	8x9	182	Satin Chrome Finished	10
Satin	AAEI0810	8x10	182	Satin Chrome Finished	10
Satin	AAEI1011	10x11	197	Satin Chrome Finished	10
Satin	AAEI1012	10x12	217	Satin Chrome Finished	10
Satin	AAEI1013	10x13	217	Satin Chrome Finished	10
Satin	AAEI1113	11x13	217	Satin Chrome Finished	10
Satin	AAEI1213	12x13	218	Satin Chrome Finished	10
Satin	AAEI1316	13x16	245	Satin Chrome Finished	10
Satin	AAEI1317	13x17	245	Satin Chrome Finished	10
Satin	AAEI1415	14x15	238	Satin Chrome Finished	10
Satin	AAEI1417	14x17	245	Satin Chrome Finished	10
Satin	AAEI1617	16x17	258	Satin Chrome Finished	5
Satin	AAEI1618	16x18	258	Satin Chrome Finished	5
Satin	AAEI1719	17x19	290	Satin Chrome Finished	5
Satin	AAEI1819	18x19	290	Satin Chrome Finished	5
Satin	AAEI1821	18x21	296	Satin Chrome Finished	5
Satin	AAEI1922	19x22	296	Satin Chrome Finished	5
Satin	AAEI2022	20x22	316	Satin Chrome Finished	5
Satin	AAEI2123	21x23	316	Satin Chrome Finished	5
Satin	AAEI2224	22x24	324	Satin Chrome Finished	5
Satin	AAEI2426	24x26	328	Satin Chrome Finished	5
Satin	AAEI2427	24x27	328	Satin Chrome Finished	5
Satin	AAEI2528	25x28	345	Satin Chrome Finished	5
Satin	AAEI2628	26x28	345	Satin Chrome Finished	5
Satin	AAEI2729	27x29	353	Satin Chrome Finished	2
Satin	AAEI2730	27x30	353	Satin Chrome Finished	2
Satin	AAEI2732	27x32	353	Satin Chrome Finished	2
Satin	AAEI3032	30x32	360	Satin Chrome Finished	2
Satin	AAEI3034	30x34	402	Satin Chrome Finished	2
Satin	AAEI3036	30x36	402	Satin Chrome Finished	2
Satin	AAEI3236	32x36	402	Satin Chrome Finished	2
Satin	AAEI3436	34x36	440	Satin Chrome Finished	2
Satin	AAEI3538	35x38	440	Satin Chrome Finished	2
Satin	AAEI3641	36x41	440	Satin Chrome Finished	2
Satin	AAEI3842	38x42	440	Satin Chrome Finished	2
Satin	AAEI4146	41x46	470	Satin Chrome Finished	2
Satin	AAEI4650	46x50	510	Satin Chrome Finished	2

SAE	ITEM NO.	SIZE(inch)	L(mm)	Finish	Quantity
Satin	ACEI0810	1/4x5/16	167	Satin Chrome Finished	10
Satin	ACEI1012	5/16x3/8	182	Satin Chrome Finished	10
Satin	ACEI1214	3/8x7/16	197	Satin Chrome Finished	10
Satin	ACEI1416	7/16x1/2	217	Satin Chrome Finished	10
Satin	ACEI1618	1/2x9/16	238	Satin Chrome Finished	10
Satin	ACEI1922	19/32x11/16	245	Satin Chrome Finished	10
Satin	ACEI2022	5/8x11/16	258	Satin Chrome Finished	5
Satin	ACEI2224	11/16x3/4	290	Satin Chrome Finished	5
Satin	ACEI2226	11/16x13/16	290	Satin Chrome Finished	5
Satin	ACEI2426	3/4x13/16	296	Satin Chrome Finished	5
Satin	ACEI2830	7/8x15/16	324	Satin Chrome Finished	5
Satin	ACEI3234	1x1-1/16	345	Satin Chrome Finished	5
Satin	ACEI3236	1x1-1/8	345	Satin Chrome Finished	5
Satin	ACEI3440	1-1/16x1-1/4	353	Satin Chrome Finished	2
Satin	ACEI3640	1-1/8x1-1/4	360	Satin Chrome Finished	2

91 **Wrenches & Torque Wrenches**

POUCH BAG - GREEN 10PCS 75° Offset Double Ring Wrench Set

10PCS

POUCH BAG - BLACK 10PCS 75° Offset Double Ring Wrench Set

10PCS

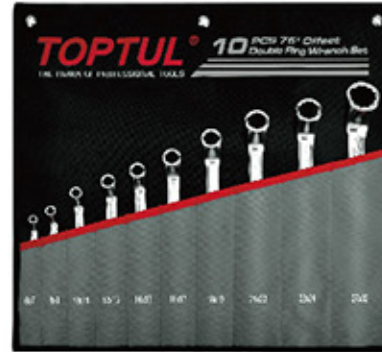

Satin Chrome Finished

ITEM NO.	CONTENTS	6 (SET)
GAA1001	6x7, 8x9, 10x11, 12x13, 14x15, 16x17, 18x19, 20x22, 21x23, 24x27	

Satin Chrome Finished

ITEM NO.	CONTENTS	6 (SET)
GPC1001	6x7, 8x9, 10x11, 12x13, 14x15, 16x17, 18x19, 21x23, 22x24, 27x32	

POUCH BAG - GREEN 8PCS 75° Offset Double Ring Wrench Set

8PCS

POUCH BAG - BLACK 8PCS 75° Offset Double Ring Wrench Set

8PCS



Satin Chrome Finished

ITEM NO.	CONTENTS	6 (SET)
GAAA0810	6x7, 8x9, 10x11, 12x13, 14x15, 16x17, 18x19, 20x22	

Satin Chrome Finished

ITEM NO.	CONTENTS	6 (SET)
GPA10802	6x7, 8x9, 10x11, 12x13, 14x15, 16x17, 18x19, 20x22	

POUCH BAG - GREEN 12PCS 75° Offset Double Ring Wrench Set

12PCS

POUCH BAG - BLACK 12PCS 75° Offset Double Ring Wrench Set

12PCS



Mirror / Satin Chrome Finished

ITEM NO.	CONTENTS	6 (SET)
GAAA1203	6x7, 8x9, 10x11, 12x13, 14x15, 16x17, 18x19, 20x22, 21x23, 24x27, 25x28, 30x32	
GAAA1204		

Satin Chrome Finished

ITEM NO.	CONTENTS	6 (SET)
GPA11202	6x7, 8x9, 10x11, 12x13, 14x15, 16x17, 18x19, 20x22, 21x23, 24x27, 25x28, 30x32	

STORAGE RACK 75° Offset Double Ring Wrench Set

6PCS

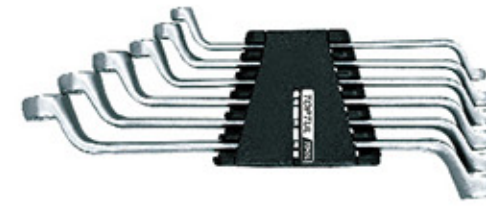

Satin Chrome Finished

ITEM NO.	CONTENTS	5 (SET)
GAAC0602	6x7, 8x9, 10x11, 12x13, 14x15, 16x17	

METAL BOX 75° Offset Double Ring Wrench Set

8PCS



Satin Chrome Finished

ITEM NO.	CONTENTS	6 (SET)
GAAD0807	6x7, 8x9, 10x11, 12x13, 14x15, 16x17, 18x19, 20x22	
METAL CASE: W370 x D154 x H50 (mm)		

COLOR BOX 75° Offset Double Ring Wrench Set

\*



Satin Chrome Finished

ITEM NO.	CONTENTS	10 (SET)
GAAE0813	6x7, 8x9, 10x11, 12x13, 14x15, 16x17, 18x19, 20x22	



**TOPTUL**  
Double Ring Wrench 75° Offset

# 93 Wrenches & Torque Wrenches

## Double Ring Wrench 45° Offset

- Chrome Vanadium Steel Material
- 45° offset ring end in design for convenient operation in recess
- Professional quality for maximum durability and corrosion resistance

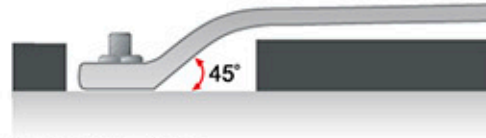

## Double Ring Wrench 45° Offset

- Chrome Vanadium Steel Material
- 45° offset ring end in design for convenient operation in recess
- Professional quality for maximum durability and corrosion resistance



METRIC		Mirror Polished	
ITEM NO.	SIZE(mm)	L(mm)	Hand
AAAH0608	6x8	165	10
AAAH0809	8x9	170	10
AAAH1011	10x11	180	10
AAAH1113	11x13	206	10
AAAH1213	12x13	206	10
AAAH1214	12x14	206	10
AAAH1415	14x15	232	10
AAAH1617	16x17	237	10
AAAH1719	17x19	270	10
AAAH1819	18x19	270	10
AAAH1922	19x22	292	5
AAAH2022	20x22	292	5
AAAH2123	21x23	327	5
AAAH2224	22x24	327	5
AAAH2326	23x26	362	5
AAAH2426	24x26	362	5
AAAH2427	24x27	362	5
AAAH2430	24x30	372	5
AAAH2528	25x28	372	5
AAAH2629	26x29	372	5
AAAH2729	27x29	380	5
AAAH2730	27x30	380	5
AAAH2732	27x32	380	5
AAAH2932	29x32	392	2
AAAH3032	30x32	392	2
AAAH3641	36x41	440	2
AAAH4146	41x46	470	2
AAAH4650	46x50	510	2
AAAH5560	55x60	610	2

METRIC		Satin Chrome Finished	
ITEM NO.	SIZE(mm)	L(mm)	Hand
AAEH0607	6x7	165	10
AAEH0608	6x8	165	10
AAEH0708	7x8	165	10
AAEH0809	8x9	170	10
AAEH0810	8x10	170	10
AAEH1011	10x11	180	10
AAEH1012	10x12	195	10
AAEH1113	11x13	206	10
AAEH1213	12x13	206	10
AAEH1214	12x14	206	10
AAEH1415	14x15	232	10
AAEH1317	13x17	237	10
AAEH1417	14x17	237	10
AAEH1617	16x17	237	10
AAEH1719	17x19	270	10
AAEH1819	18x19	270	10
AAEH1921	19x21	292	5
AAEH1922	19x22	292	5
AAEH2022	20x22	292	5
AAEH2123	21x23	327	5
AAEH2224	22x24	327	5
AAEH2326	23x26	362	5
AAEH2426	24x26	362	5
AAEH2427	24x27	362	5
AAEH2528	25x28	372	5
AAEH2628	26x28	372	5
AAEH2629	26x29	372	5
AAEH2729	27x29	380	5
AAEH2730	27x30	380	5
AAEH2732	27x32	380	5
AAEH3032	30x32	392	2
AAEH3034	30x34	402	2
AAEH3236	32x36	402	2
AAEH3436	34x36	440	2
AAEH3641	36x41	440	2
AAEH3842	38x42	440	2
AAEH4146	41x46	470	2
AAEH4650	46x50	510	2
AAEH5560	55x60	610	2

SAE		Mirror Polished	
ITEM NO.	SIZE(inch)	L(mm)	Hand
ACAHO810	1/4x5/16	165	10
ACAHO1012	5/16x3/8	170	10
ACAHO1214	3/8x7/16	180	10
ACAHO1416	7/16x1/2	206	10
ACAHO1618	1/2x9/16	206	10
ACAHO1820	9/16x5/8	232	10
ACAHO1922	19/32x11/16	237	10
ACAHO2022	5/8x11/16	237	10
ACAHO2224	11/16x3/4	270	10
ACAHO2425	3/4x25/32	270	10
ACAHO2426	3/4x13/16	292	5
ACAHO2428	3/4x7/8	292	5
ACAHO2628	13/16x7/8	292	5
ACAHO2830	7/8x15/16	327	5
ACAHO3032	15/16x1	362	5
ACAHO3236	1x1-1/8	372	5
ACAHO3436	1-1/16x1-1/8	372	5
ACAHO3440	1-1/16x1-1/4	392	2
ACAHO3640	1-1/8x1-1/4	392	2
ACAHO4046	1-1/4x1-7/16	402	2
ACAHO4248	1-5/16x1-1/2	440	2
ACAHO4652	1-7/16x1-5/8	440	2
ACAHO5258	1-5/8x1-13/16	470	2
ACAHO5460	1-11/16x1-7/8	470	2
ACAHO5864	1-13/16x2	510	2
ACAHO7278	2-1/4x2-7/16	610	2

SAE		Satin Chrome Finished	
ITEM NO.	SIZE(inch)	L(mm)	Hand
ACEHO810	1/4x5/16	165	10
ACEHO1012	5/16x3/8	170	10
ACEHO1214	3/8x7/16	180	10
ACEHO1416	7/16x1/2	206	10
ACEHO1618	1/2x9/16	206	10
ACEHO1820	9/16x5/8	232	10
ACEHO2022	5/8x11/16	237	10
ACEHO2426	3/4x13/16	292	5
ACEHO2830	7/8x15/16	327	5
ACEHO3032	15/16x1	362	5
ACEHO3436	1-1/16x1-1/8	372	5
ACEHO3440	1-1/16x1-1/4	392	2
ACEHO3640	1-1/8x1-1/4	392	2
ACEHO4044	1-1/4x1-3/8	402	2
ACEHO4046	1-1/4x1-7/16	402	2
ACEHO5258	1-5/8x1-13/16	470	2
ACEHO7076	2-3/16x2-3/8	610	2

## COLOR BOX 45° Offset Double Ring Wrench Set

## POUCH BAG - BLACK 45° Offset Double Ring Wrench Set



ITEM NO.	CONTENTS	Hand
GAAE0815	6x7, 8x9, 10x11, 12x13, 14x15, 16x17, 18x19, 20x22	10

ITEM NO.	CONTENTS	Hand
GPAH0801	6x7, 8x9, 10x11, 12x13, 14x15, 16x17, 18x19, 22x24	10
GPAH0802	6x7, 8x9, 10x11, 12x13, 14x15, 16x17, 18x19, 22x24	10

## METAL BOX 45° Offset Double Ring Wrench Set

## POUCH BAG - BLACK 45° Offset Double Ring Wrench Set



ITEM NO.	CONTENTS	Hand
GAAD0804	6x7, 8x9, 10x11, 12x13, 14x15, 16x17, 18x19, 20x22	10

ITEM NO.	CONTENTS	Hand
GPAH0804	6x7, 8x9, 10x11, 12x13, 14x15, 16x17, 18x19, 20x22	10

## POUCH BAG - GREEN 45° Offset Double Ring Wrench Set

## POUCH BAG - BLACK 45° Offset Double Ring Wrench Set



ITEM NO.	CONTENTS	Hand
GAAA1202	6x7, 8x9, 10x11, 12x13, 14x15, 16x17, 18x19, 20x22, 21x23, 24x27, 25x28, 30x32	10

ITEM NO.	CONTENTS	Hand
GPAH1202	6x7, 8x9, 10x11, 12x13, 14x15, 16x17, 18x19, 20x22, 21x23, 24x27, 25x28, 30x32	10

**STAR WRENCH**



- Star Wrench
- Chrome Vanadium Steel Material
- Useful for removing E-Torx fasteners
- Professional quality for maximum durability and corrosion resistance

- Star Wrench
- Chrome Vanadium Steel Material
- Useful for removing E-Torx fasteners
- Professional quality for maximum durability and corrosion resistance

ITEM NO.	SIZE	L(mm)	Hand	Weight
AAEE0608	E6xE8	113	10	320
AAEE0711	E7xE11	127	10	320
AAEE1012	E10xE12	142	10	320
AAEE1418	E14xE18	181	10	240
AAEE1622	E16xE22	204	5	40
AAEE2024	E20xE24	224	5	40

- 6PT - Flare Nut Wrench
- Chrome Vanadium Steel Material
- Thick head feature ensures a strong grip on the nut and avoids damages
- Useful for tightening and loosening flare nuts at line connections
- Specially designed for use with nuts fitted in hydraulic, oil and compressed air systems

ITEM NO.	SIZE(inch)	L(mm)	Hand	Weight
AFEA1012	5/16x3/8	130	15	240
AFEA1214	3/8x7/16	150	10	160
AFEA1416	7/16x1/2	170	10	120
AFEA1618	1/2x9/16	170	10	120

- 12PT - Flare Nut Wrench
- Chrome Vanadium Steel Material
- Thick head feature ensures a strong grip on the nut and avoids damages
- Useful for tightening and loosening flare nuts at line connections
- Specially designed for use with nuts fitted in hydraulic, oil and compressed air systems

ITEM NO.	SIZE(inch)	L(mm)	Hand	Weight
AFEA1820	9/16x5/8	190	5	60
AFEA2022	5/8x11/16	195	5	60
AFEA2024	5/8x3/4	210	5	40
AFEA2224	11/16x3/4	210	5	40
AFEA2428	3/4x7/8	230	5	40

- POUCH BAG - BLACK
- Flare Nut Wrench Set



ITEM NO.	CONTENTS
GPAQ0502	8x10, 11x13, 12x14, 17x19, 22x24

5PCS

**Wrenches & Torque Wrenches**

- 6PT - Flare Nut Wrench
- Chrome Vanadium Steel Material
- Thick head feature ensures a strong grip on the nut and avoids damages
- Useful for tightening and loosening flare nuts at line connections
- Specially designed for use with nuts fitted in hydraulic, oil and compressed air systems

ITEM NO.	SIZE(mm)	L(mm)	Hand	Weight
AEAA0809	8x9	130	15	240
AEAA1011	10x11	150	10	160
AEAA1113	11x13	170	10	120
AEAA1213	12x13	170	10	120

- 6PT - Flare Nut Wrench
- Chrome Vanadium Steel Material
- Thick head feature ensures a strong grip on the nut and avoids damages
- Useful for tightening and loosening flare nuts at line connections
- Specially designed for use with nuts fitted in hydraulic, oil and compressed air systems

ITEM NO.	SIZE(inch)	L(mm)	Hand	Weight
AFAA1214	3/8x7/16	150	10	160
AFAA1416	7/16x1/2	170	10	120
AFAA1618	1/2x9/16	170	10	120

- 6PT - Flare Nut Wrench
- Chrome Vanadium Steel Material
- Thick head feature ensures a strong grip on the nut and avoids damages
- Useful for tightening and loosening flare nuts at line connections
- Specially designed for use with nuts fitted in hydraulic, oil and compressed air systems

ITEM NO.	SIZE(mm)	L(mm)	Hand	Weight
AEAA0809	8x9	130	15	240
AEAA0810	8x10	130	15	240
AEAA1011	10x11	150	10	160
AEAA1012	10x12	150	10	160
AEAA1113	11x13	170	10	120
AEAA1213	12x13	170	10	120
AEAA1214	12x14	170	10	120

- 12PT - Flare Nut Wrench
- Chrome Vanadium Steel Material
- Thick head feature ensures a strong grip on the nut and avoids damages
- Useful for tightening and loosening flare nuts at line connections
- Specially designed for use with nuts fitted in hydraulic, oil and compressed air systems

ITEM NO.	SIZE(mm)	L(mm)	Hand	Weight
AEAA1417	14x17	190	5	60
AEAA1618	16x18	210	5	40
AEAA1922	19x22	230	5	40
AEAA2224	22x24	252	5	40

- 12PT - Flare Nut Wrench
- Chrome Vanadium Steel Material
- Thick head feature ensures a strong grip on the nut and avoids damages
- Useful for tightening and loosening flare nuts at line connections
- Specially designed for use with nuts fitted in hydraulic, oil and compressed air systems

ITEM NO.	SIZE(inch)	L(mm)	Hand	Weight
AFAA1820	9/16x5/8	190	5	60
AFAA2224	11/16x3/4	210	5	40
AFAA2428	3/4x7/8	230	5	40

- 12PT - Flare Nut Wrench
- Chrome Vanadium Steel Material
- Thick head feature ensures a strong grip on the nut and avoids damages
- Useful for tightening and loosening flare nuts at line connections
- Specially designed for use with nuts fitted in hydraulic, oil and compressed air systems

ITEM NO.	SIZE(mm)	L(mm)	Hand	Weight
AEAA1417	14x17	190	5	60
AEAA1618	16x18	210	5	40
AEAA1719	17x19	210	5	40
AEAA1922	19x22	230	5	40
AEAA2224	22x24	252	5	40
AEAA2427	24x27	265	5	40

97 **Wrenches & Torque Wrenches**

**Flat Type Extra-Long Double Ring Wrench**

- Chrome Molybdenum Steel Material
- Professional quality for maximum durability and corrosion resistance
- Long shank and thin wall ring end design for reaching bolts easily in deep restricted space



ITEM NO.	SIZE(mm)	L(mm)	Mirror Polished	
Mirror			👤	📦
AAAP081012	8x10	230	15	120
AAAP101212	10x12	300	15	90
AAAP121412	12x14	333	10	60
AAAP141712	14x17	365	10	60

**Half-Moon Ring Wrench**

- Chrome Vanadium Steel Material
- Special purpose tool for hard to reach starter bolts
- Professional quality for maximum durability and corrosion resistance



ITEM NO.	SIZE(mm)	L(mm)	Mirror Polished	
Mirror			👤	📦
AAAC080912	8x9	137	10	160
AAAC161812	16x18	220	5	40
AAAC192212	19x22	256	5	40

**Flat Type Extra-Long Double Ring Wrench**

- Chrome Molybdenum Steel Material
- Professional quality for maximum durability and corrosion resistance
- Long shank and thin wall ring end design for reaching bolts easily in deep restricted space



ITEM NO.	SIZE(mm)	L(mm)	Satin Chrome Finished	
Satin			👤	📦
AAAP081052	8x10	230	15	120
AAAP101252	10x12	300	15	90
AAAP121452	12x14	333	10	60
AAAP141752	14x17	365	10	60
AAAP171952	17x19	400	5	30
AAAP222452	22x24	430	5	30

**Half-Moon Ring Wrench**

- Chrome Vanadium Steel Material
- Special purpose tool for hard to reach starter bolts
- Professional quality for maximum durability and corrosion resistance



ITEM NO.	SIZE(mm)	L(mm)	Satin Chrome Finished	
Satin			👤	📦
AAAC080952	8x9	137	10	160
AAAC101252	10x12	142	10	160
AAAC111352	11x13	166	5	80
AAAC141752	14x17	190	5	80
AAAC161852	16x18	220	5	40
AAAC192252	19x22	256	5	40

**POUCH BAG - BLACK**

6PCS

Flat Type Extra-Long Double Ring Wrench Set



ITEM NO.	CONTENTS	Mirror / Satin Chrome Finished
GPAP0601	8x10, 10x12, 12x14, 14x17, 17x19, 22x24	👤 12 (SET)
GPAP0602		



**MIDGET DOUBLE RING WRENCH 45° OFFSET**



**Midget Double Ring Wrench 45° Offset**

- Chrome Vanadium Steel Material
- Short shank allows convenient operation in confined area
- Professional quality for maximum durability and corrosion resistance



ITEM NO.	SIZE(mm)	L(mm)	Mirror Polished	
Mirror			👤	📦
AAAK101112	10x11	116	10	160
AAAK121312	12x13	141	10	160
AAAK141512	14x15	141	10	160
AAAK161712	16x17	158	10	120
AAAK181912	18x19	158	10	120

**Midget Double Ring Wrench 45° Offset**

- Chrome Vanadium Steel Material
- Short shank allows convenient operation in confined area
- Professional quality for maximum durability and corrosion resistance



ITEM NO.	SIZE(mm)	L(mm)	Satin Chrome Finished	
Satin			👤	📦
AAAK080952	8x9	116	10	160
AAAK101152	10x11	116	10	160
AAAK121352	12x13	141	10	160
AAAK141552	14x15	141	10	160
AAAK161752	16x17	158	10	120
AAAK181952	18x19	158	10	120

**Midget Dynamic Combination Wrench 15° Offset**

- Chrome Vanadium Steel Material
- Short shank allows convenient operation in confined area
- Patent dynamic open end in design for operating within 30° restricted space



ITEM NO.	SIZE(mm)	L(mm)	Mirror Polished	
Mirror			👤	📦
AAAG0707	7	86	10	320
AAAG0808	8	86	10	320
AAAG0909	9	95	10	320
AAAG1010	10	95	10	320
AAAG1111	11	99	10	320
AAAG1313	13	107	10	320
AAAG1414	14	113	10	160
AAAG1515	15	117	10	160
AAAG1616	16	121	10	160
AAAG1717	17	127	10	120
AAAG1818	18	131	10	120
AAAG1919	19	137	10	120

**Midget Dynamic Combination Wrench 15° Offset**

- Chrome Vanadium Steel Material
- Short shank allows convenient operation in confined area
- Patent dynamic open end in design for operating within 30° restricted space



ITEM NO.	SIZE(inch)	L(mm)	Mirror Polished	
Mirror			👤	📦
ACAG1010	5/16	86	10	320
ACAG1212	3/8	95	10	320
ACAG1414	7/16	99	10	320
ACAG1616	1/2	107	10	320
ACAG1818	9/16	113	10	160
ACAG2020	5/8	121	10	160
ACAG2222	11/16	127	10	120
ACAG2424	3/4	137	10	120

**10PCS**

Miniature Combination Wrench Set



ITEM NO.	CONTENTS	Mirror Polished
GBBA1001	AFAM0505-1414 5/32", 3/16" 7/32", 15/64", 1/4", 9/32", 5/16", 11/32", 3/8", 7/16"	👤 10 (SET)





99 **Wrenches & Torque Wrenches**

- Midget Combination Wrench 15° Offset**  
 • Chrome Vanadium Steel Material  
 • Short shank in design for convenient operation in confined area  
 • Professional quality for maximum durability and corrosion resistance



- Midget Combination Wrench 15° Offset**  
 • Chrome Vanadium Steel Material  
 • Short shank in design for convenient operation in confined area  
 • Professional quality for maximum durability and corrosion resistance



ITEM NO.	SIZE(mm)	L(mm)	Mirror Polished	
			Hand	Box
AAAF070712	7	86	10	320
AAAF080812	8	86	10	320
AAAF090912	9	95	10	320
AAAF101012	10	95	10	320
AAAF111112	11	99	10	320
AAAF131312	13	107	10	320
AAAF141412	14	113	10	160
AAAF151512	15	117	10	160
AAAF161612	16	121	10	160
AAAF181812	18	131	10	120

ITEM NO.	SIZE(mm)	L(mm)	Satin Chrome Finished	
			Hand	Box
AAAF070752	7	86	10	320
AAAF080852	8	86	10	320
AAAF090952	9	95	10	320
AAAF101052	10	95	10	320
AAAF111152	11	99	10	320
AAAF121252	12	103	10	320
AAAF131352	13	107	10	320
AAAF141452	14	113	10	160
AAAF151552	15	117	10	160
AAAF161652	16	121	10	160
AAAF171752	17	127	10	120
AAAF181852	18	131	10	120
AAAF191952	19	137	10	120

- Midget Combination Wrench 15° Offset**  
 • Chrome Vanadium Steel Material  
 • Short shank in design for convenient operation in confined area  
 • Professional quality for maximum durability and corrosion resistance



- Midget Combination Wrench 15° Offset**  
 • Chrome Vanadium Steel Material  
 • Short shank in design for convenient operation in confined area  
 • Professional quality for maximum durability and corrosion resistance



ITEM NO.	SIZE(inch)	L(mm)	Mirror Polished	
			Hand	Box
ACAF111112	11/32	95	10	320
ACAF121212	3/8	95	10	320
ACAF141412	7/16	99	10	320
ACAF202012	5/8	121	10	160
ACAF242412	3/4	137	10	120

ITEM NO.	SIZE(inch)	L(mm)	Satin Chrome Finished	
			Hand	Box
ACAF101052	5/16	86	10	320
ACAF111152	11/32	95	10	320
ACAF121252	3/8	95	10	320
ACAF141452	7/16	99	10	320
ACAF161652	1/2	107	10	320
ACAF181852	9/16	113	10	160
ACAF202052	5/8	121	10	160
ACAF222252	11/16	127	10	120
ACAF242452	3/4	137	10	120

- POUCH BAG - GREEN** 10PCS  
 15° Offset Midget Combination Wrench Set

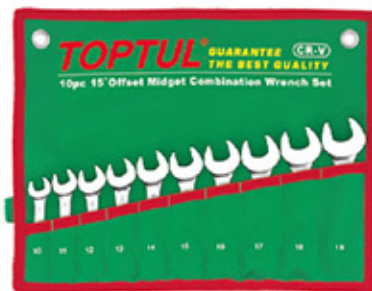

ITEM NO.	CONTENTS	Satin Chrome Finished
GAAA1002	10, 11, 12, 13, 14, 15, 16, 17, 18, 19	20 (SET)



- Pro-Series Reversible Ratchet Combination Wrench**  
 • Chrome Vanadium Steel Material  
 • Two-way reversible gear design for quick and easy fastening and loosening works  
 • 72 teeth ratchet mechanism, 5° increments  
 • High torque & durable ratcheting performance  
 • Stain chrome plated finish



ITEM NO.	SIZE(mm)	L(mm)	Satin Chrome Finished	
			Hand	Box
ABAF0808	8	140	10	320
ABAF0909	9	149	10	320
ABAF1010	10	158	10	160
ABAF1111	11	165	10	120
ABAF1212	12	171	10	120
ABAF1313	13	178	10	120
ABAF1414	14	190	10	120
ABAF1515	15	199	10	80
ABAF1616	16	208	10	80
ABAF1717	17	225	10	80
ABAF1818	18	236	10	80
ABAF1919	19	247	10	80
ABAF2222	22	288	5	40
ABAF2424	24	321	5	40
ABAF2727	27	357	5	20
ABAF3030	30	400	2	16
ABAF3232	32	423	2	12

- STORAGE RACK** 7PCS  
 Pro-Series Reversible Ratchet Combination Wrench Set



ITEM NO.	CONTENTS	Satin Chrome Finished
GAAM0709	8, 10, 12, 13, 14, 17, 19	2 (SET)



- POUCH BAG - BLACK** 12PCS  
 Pro-Series Reversible Ratchet Combination Wrench Set

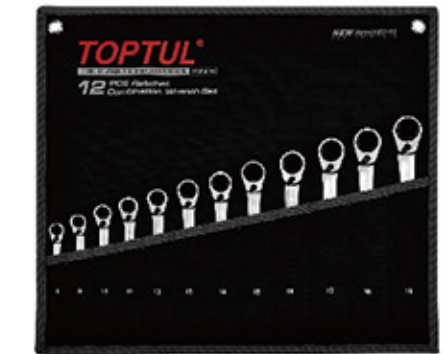

ITEM NO.	CONTENTS	Satin Chrome Finished
GPAQ1203	8, 9, 10, 11, 12, 13, 14, 15, 16, 17, 18, 19	10 (SET)

- METAL BOX** 15PCS  
 Pro-Series Reversible Ratchet Combination Wrench Set



ITEM NO.	Black	GBA1541	Satin Chrome Finished
<b>CONTENTS</b>			
12 ABAF0808~1919 72 Teeth Pro-Series Reversible Ratchet Combination Wrenches 8, 9, 10, 11, 12, 13, 14, 15, 16, 17, 18, 19 mm			
3 CANA0810~1619 Socket Adapter with Quick Release (For Ratchet Wrench) ■ 1/4" x 10mm, ■ 3/8" x 13mm, ■ 1/2" x 19mm			
METAL CASE: W361 x D137 x H53 (mm)			

- METAL BOX** 12PCS  
 Pro-Series Reversible Ratchet Combination Wrench Set



ITEM NO.	CONTENTS	Satin Chrome Finished
GAAD1205	8, 9, 10, 11, 12, 13, 14, 15, 16, 17, 18, 19	6 (SET)
METAL CASE: W370 x D154 x H50 (mm)		



Improved Box End Strength & Durability 5° Operating Angle

Strong Open End Design DIN Standard

Chrome Vanadium Alloy Steel Satin Chrome Finish

HIGH PERFORMANCE RATCHET COMBINATION WRENCH

**Pro-Series Ratchet Combination Wrench**

- Chrome Vanadium Steel Material
- 72 teeth ratchet mechanism, 5° increments
- High torque & durable ratcheting performance
- Satin chrome plated finish



ITEM NO.	SIZE(mm)	L(mm)	Hand	Weight (g)
AOAF0808	8	140	10	320
AOAF0909	9	149	10	160
AOAF1010	10	158	10	160
AOAF1111	11	165	10	120
AOAF1212	12	171	10	120
AOAF1313	13	178	10	120
AOAF1414	14	190	10	120
AOAF1515	15	200	10	80
AOAF1616	16	208	10	80
AOAF1717	17	225	10	80
AOAF1818	18	236	10	80
AOAF1919	19	247	10	80
AOAF2222	22	289	5	40
AOAF2424	24	322	5	40

**POUCH BAG - BLACK 12PCS**  
Ratchet Combination Wrench Set



ITEM NO.	CONTENTS
GPAQ1202	8, 9, 10, 11, 12, 13, 14, 15, 16, 17, 18, 19

**METAL BOX 8PCS**  
Pro-Series Ratchet Combination Wrench Set



ITEM NO.	CONTENTS
GAAD0810	8, 10, 11, 12, 13, 14, 17, 19

**10PCS**  
Pro-Series Ratchet Combination Wrench Set



ITEM NO.	CONTENTS
GAAI1004	<ul style="list-style-type: none"> <li>• AOAF0808-1919 Pro-Series Ratchet Combination Wrenches 8, 10, 12, 13, 17, 19 mm</li> <li>• CANA0810-1619 Socket Adapter with Quick Release (For Ratchet Wrench) 1/4" x 10mm, 3/8" x 13mm, 1/2" x 19mm</li> <li>• FTAB0810 Quick Change Bit Holder 1/4" x 10mm</li> </ul>

BLOW CASE: W260 x D170 x H60 (mm)

METAL CASE: W370 x D154 x H50 (mm)

**Pro-Series Ratchet Double Ring Wrench**

- Chrome Vanadium Steel Material
- 72 teeth ratchet mechanism, 5° increments
- High torque & durable ratcheting performance



ITEM NO.	SIZE(mm)	L(mm)	Hand	Weight (g)
AOAG0809	8x9	128	10	320
AOAG1011	10x11	150	10	160
AOAG1213	12x13	170	10	160
AOAG1415	14x15	190	10	120
AOAG1618	16x18	210	10	80
AOAG1719	17x19	230	10	80

**Pro-Series 4-In-1 Ratchet Double Ring Wrench**

- Chrome Vanadium Steel Material
- Two-way reversible gear design for quick and easy fastening and loosening works
- 72 teeth ratchet mechanism, 5° increments
- High torque & durable ratcheting performance



ITEM NO.	SIZE(mm)	L(mm)	Hand	Weight (g)
ABAD0811	8x11-10x9	150	10	160
ABAD1215	12x15-14x13	190	5	80
ABAD1619	16x19-17x18	230	5	40



Pro-Series 4-In-1 Ratchet Double Ring Wrench

**Reversible Ratchet Combination Wrench**

- Chrome Vanadium Steel Material
- Two-way reversible gear design for quick and easy fastening and loosening works
- 72 teeth gear construction for optimum fastening efficiency with only 5° increment of a turn



ITEM NO.	SIZE(mm)	L(mm)	Hand	Weight (g)
ABEA0808	8	135	10	320
ABEA0909	9	145	10	320
ABEA1010	10	155	10	160
ABEA1111	11	165	10	120
ABEA1212	12	175	10	120
ABEA1313	13	185	10	120
ABEA1414	14	195	10	120
ABEA1515	15	205	10	80
ABEA1616	16	215	10	80
ABEA1717	17	225	10	80
ABEA1818	18	235	10	80
ABEA1919	19	245	10	80

**Reversible Ratchet Combination Wrench**

- Chrome Vanadium Steel Material
- Two-way reversible gear design for quick and easy fastening and loosening works
- 72 teeth gear construction for optimum fastening efficiency with only 5° increment of a turn



ITEM NO.	SIZE(inch)	L(mm)	Hand	Weight (g)
ADAA1010	5/16	135	10	320
ADAA1212	3/8	155	10	160
ADAA1414	7/16	165	10	120
ADAA1616	1/2	185	10	120
ADAA1818	9/16	195	10	120
ADAA2020	5/8	215	10	80
ADAA2222	11/16	225	10	80
ADAA2424	3/4	245	10	80

**METAL BOX 8PCS**  
Reversible Ratchet Combination Wrench Set (SAE)



ITEM NO.	CONTENTS
GBAD0802	5/16", 3/8", 7/16", 1/2", 9/16", 5/8", 11/16", 3/4"

METAL CASE: W370 x D154 x H50 (mm)

103 **Wrenches & Torque Wrenches**



- Flexible Ratchet Combination Wrench** ★
- Chrome Vanadium Steel Material
  - 72 Teeth Ratchet Mechanism (5° increments)
  - Satin Chrome Finished
  - The pivoting flexible ratchet ring head allows for 180 degree operation in confined spaces
  - Compact ring head enables to work in tight spaces where a ratchet and socket would not fit
  - Ideal for applications that present problems in terms of congestion, visibility and accessibility

- POUCH BAG - BLACK** ★ **12PCS**
- Flexible Ratchet Combination Wrench Set

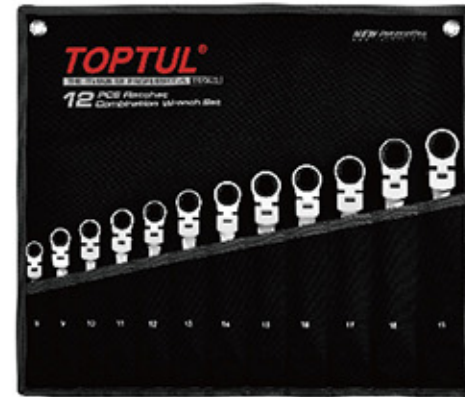

ITEM NO.	CONTENTS	Satin Chrome Finished
GPAQ1204	8, 9, 10, 11, 12, 13, 14, 15, 16, 17, 18, 19	10 (SET)



ITEM NO.	SIZE(mm)	L(mm)	Satin Chrome Finished	
Satin			👉	📦
AOAD0909	9	158	10	320
AOAD1111	11	175	10	120
AOAD1414	14	193	10	120
AOAD1515	15	213	10	80
AOAD1616	16	213	10	80
AOAD1717	17	231	10	80
AOAD1818	18	249	10	80

- 10PCS** ★
- Flexible Ratchet Combination Wrench Set



ITEM NO.	CONTENTS	Satin Chrome Finished
GAA1003	4 AOAD0808-1919 Flexible Ratchet Combination Wrenches 8, 10, 12, 13, 17, 19 mm 3 CANA0810-1619 Socket Adapter with Quick Release (For Ratchet Wrench) 1/4" x 10mm, 3/8" x 13mm, 1/2" x 19mm 1 FTAB0810 Quick Change Bit Holder 1/4" x 10mm	10 (SET)
BLOW CASE: W260 x D170 x H60 (mm)		

- Ratchet Combination Wrench** ★
- Chrome Vanadium Steel Material
  - 72 Teeth Ratchet Mechanism



ITEM NO.	SIZE(mm)	L(mm)	Satin Chrome Finished	
Satin			👉	📦
AOAA0808	8	135	10	320
AOAA0909	9	158	10	160
AOAA1010	10	158	10	160
AOAA1111	11	164	10	120
AOAA1212	12	167	10	120
AOAA1313	13	176	10	120
AOAA1414	14	190	10	120
AOAA1515	15	199	10	80
AOAA1616	16	205	10	80
AOAA1717	17	223	10	80
AOAA1919	19	245	10	80
AOAA2222	22	278	5	40
AOAA2424	24	308	5	40

- Stubby Ratchet Combination Wrench**
- Chrome Vanadium Steel Material
  - 72 Teeth Ratchet Mechanism



ITEM NO.	SIZE(mm)	L(mm)	Satin Chrome Finished	
Satin			👉	📦
AOAB0808	8	93	10	320
AOAB0909	9	95	10	320
AOAB1010	10	95	10	320
AOAB1111	11	105	10	320
AOAB1212	12	105	10	320
AOAB1313	13	106	10	320
AOAB1414	14	115	10	160
AOAB1515	15	122	10	160
AOAB1616	16	122	10	160
AOAB1717	17	125	10	120
AOAB1818	18	138	10	120
AOAB1919	19	138	10	120

- Flexible Ratchet Double Ring Wrench** ★
- Chrome Vanadium Steel Material
  - 72 teeth ratchet mechanism (5° increments)
  - Satin chrome finished
  - The pivoting flexible ratchet ring head allows for 180 degree operation in confined spaces
  - Compact ring head enables to work in tight spaces where a ratchet and socket would not fit
  - Ideal for applications that present problems in terms of congestion, visibility and accessibility



ITEM NO.	SIZE(mm)	L(mm)	Satin Chrome Finished	
Satin			👉	📦
AOAE0809	8x9	182	10	120
AOAE1011	10x11	188	10	120
AOAE1213	12x13	213	10	80
AOAE1618	16x18	235	10	80
AOAE1719	17x19	238	10	80

- Ratchet Double Ring Wrench** ★
- Chrome Vanadium Steel and special heat treatments provides thin walls for strength
  - 72 teeth ratcheting system provides high torque and 5 degrees of operation in tight areas



ITEM NO.	SIZE(mm)	L(mm)	Satin Chrome Finished	
Satin			👉	📦
AEAR0809	8x9	131	10	320
AEAR1011	10x11	144	10	160
AEAR1618	16x18	206	10	80

- Socket Adapter With Quick Release (For Ratchet Wrench)** (CR-V) (DIN3123)



ITEM NO.	DRIVE	L(mm)	Mirror Polished	
Mirror			👉	📦
CANA0810	1/4" x 10mm	20	10	180
CANA1213	3/8" x 13mm	24	10	180
CANA1619	1/2" x 19mm	32	10	180

- Ratchet Double E-Star Ring Wrench**
- Chrome Vanadium Steel Material
  - Useful for removing external E-star fasteners quickly
  - 72 teeth ratcheting mechanism for optimum fastening efficiency



ITEM NO.	SIZE	L(mm)	Satin Chrome Finished	
Satin			👉	📦
AOAC0608	E6xE8	130	10	160
AOAC1012	E10xE12	144	10	160
AOAC1418	E14xE18	181	10	80
AOAC2024	E20xE24	224	10	80

- Quick Change Bit Holder (For Ratchet Wrench)** (CR-V)



ITEM NO.	DRIVE	L(mm)	Mirror Polished	
Mirror			👉	📦
FTAB0810	1/4" x 10mm	17	50	800

105 **Wrenches & Torque Wrenches**

**Double Socket Ratchet Wrench**

- Chrome Vanadium Steel Material
- Two-way reversible gear design for quick and easy fastening and loosening works



32 Gears / Satin Chrome Finished

ITEM NO.	SIZE(mm)	L(mm)	Hand	Weight (kg)
• AEAH1012	10x12	240	2	50
• AEAH1013	10x13	240	2	50
• AEAH1214	12x14	240	2	50
• AEAH1317	13x17	280	2	50
• AEAH1415	14x15	280	2	50
• AEAH1417	14x17	280	2	50
• AEAH1419	14x19	315	2	50
• AEAH1719	17x19	315	2	50
• AEAH1721	17x21	315	2	50
• AEAH1921	19x21	315	2	50
• AEAH1922	19x22	315	2	50
• AEAH1924	19x24	360	2	30
• AEAH2123	21x23	360	2	30
• AEAH2127	21x27	360	2	30
• AEAH2224	22x24	360	2	30
• AEAH2427	24x27	360	2	30
• AEAH2430	24x30	450	2	20
• AEAH2629	26x29	450	2	20
• AEAH2730	27x30	450	2	20
• AEAH2732	27x32	450	2	20
• AEAH3032	30x32	450	2	20
• AEAH3236	32x36	450	2	20
• AEAH3641	36x41	450	2	20
• AEAH3650	36x50	500	2	8
• AEAH3846	38x46	500	2	8
• AEAH3850	38x50	500	2	8
• AEAH4146	41x46	500	2	8
• AEAH4150	41x50	500	2	8
• AEAH4155	41x55	500	2	8
• AEAH4650	46x50	500	2	8
• AEAH4655	46x55	500	2	8
• AEAH5055	50x55	500	2	8

**Open-End Ratcheting Wrench**

- Chrome Molybdenum Steel Open-End
- Chrome Vanadium Steel Handle
- Special purpose tool for hard to reach starter bolts
- Professional quality for maximum durability and corrosion resistance



Satin Finished

ITEM NO.	SIZE(mm)	L(mm)	Hand	Weight (kg)
• AEAH1010	10	156	10	160
• AEAH1111	11	156	10	160
• AEAH1313	13	156	10	160
• AEAH1717	17	210	10	80
• AEAH1919	19	212	10	80
• AEAH2222	22	220	10	80

Adjustable Hook Spanner Wrench

**Adjustable Hook Spanner Wrench**

- Made of Chrome Vanadium Alloy Steel
- Ideal for adjusting collars, lock nut rings and bearings
- Five sizes cover the full range of conventional fixed wrenches

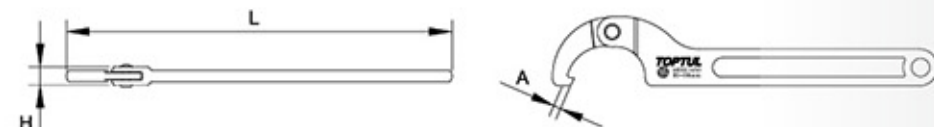

Satin Finished

ITEM NO.	Diameter Capacity (mm)	Hook Depth (A) (mm)	Hook Thickness (H) (mm)	Overall Length (L) (mm)	Hand	Weight (kg)
• AEEH1A35	13-35	3.5	9	170	5	60
• AEEH1A50	35-50	4.5	10	215	5	40
• AEEH1A80	50-80	5.5	12	285	5	40
• AEEH1AA2	80-120	6.0	13	345	5	30
• AEEH1AA8	120-180	8.0	15	465	2	8



**Aluminum Alloy Pipe Wrench**

- Aluminum alloy body
- Chrome molybdenum jaw
- Extra hardened jaw and deep milled teeth provide maximum strength at stress point
- Balanced for proper weight distribution



ITEM NO.	SIZE/LENGTH (inch)	JAW OPENING CAPACITY Ø (inch)	Hand	Weight (kg)
• DDAC1A14	14	2	2	8
• DDAC1A18	18	2-1/2	2	4
• DDAC1A24	24	3	2	4
• DDAC1A36	36	5	1	2
• DDAC1A48	48	6	1	2

**Adjustable Wrench**

- Chrome Vanadium Steel Material
- Millimeter graduation head for quick adjustment
- Black phosphate finish
- Polished head



ITEM NO.	SIZE (inch/mm)	MAXIMUM JAW OPENING WIDTH (mm)	L (mm)	Hand	Weight (kg)
• AMAC2015	6"(150mm)	20	160	6	150
• AMAC2420	8"(200mm)	24	210	6	96
• AMAC2925	10"(250mm)	29	260	6	54
• AMAC3430	12"(300mm)	34	310	6	24
• AMAC4338	15"(375mm)	43	390	2	8

**Pipe Wrench**

- Cast iron body
- Chrome molybdenum jaw



ITEM NO.	SIZE/LENGTH (inch)	JAW OPENING CAPACITY Ø (inch)	Hand	Weight (kg)
• DDAB1A08	8	1	5	40
• DDAB1A10	10	1-1/2	5	20
• DDAB1A12	12	2	2	12
• DDAB1A14	14	2	2	8
• DDAB1A18	18	2-1/2	2	4
• DDAB1A24	24	3	2	4
• DDAB1A36	36	5	1	2
• DDAB1A48	48	6	1	2

**Heavy Duty Adjustable Wrench**

- Chrome Vanadium Steel Material
- Millimeter graduation head for quick adjustment
- Industrial-grade quality for maximum durability and corrosion resistance



ITEM NO.	SIZE (inch/mm)	MAXIMUM JAW OPENING WIDTH (mm)	L (mm)	Hand	Weight (kg)
• AMAB1710	4"(100mm)	17.0	110	6	120
• AMAB2415	6"(150mm)	23.9	160	6	90
• AMAB2920	8"(200mm)	28.6	205	6	60
• AMAB3325	10"(250mm)	32.8	255	6	36
• AMAB3830	12"(300mm)	38.1	305	6	24
• AMAB5038	15"(375mm)	50.0	380	2	4
• AMAB6045	18"(450mm)	60.0	460	2	4

**Pipe Wrench (45° Swedish model pipe wrench with S-shaped jaw)**

- Swedish pattern pipe wrench
- Made of drop forged Chrome Vanadium Steel
- Slim, S-shaped jaws with induction hardened teeth
- Special jaw design grips pipes at three points
- Teeth offset against direction of rotation
- Suitable for working in confined spaces



ITEM NO.	SIZE (inch)	JAW OPENING CAPACITY Ø (inch)	L (mm)	Hand	Weight (kg)
• DDAD1A32	1	1-1/2	345	2	12
• DDAD1A48	1-1/2	2-1/4	440	2	12
• DDAD1A64	2	2-1/2	560	2	8

**Paw Adjustable Wrench**

- Chrome Vanadium Steel Material
- Millimeter graduation head for quick adjustment
- Handle weight less by 10% and over 18% wider jaw opening increase torsional rigidity and useful range of fastener sizes
- Rubber (TPR) cushion handle provides a comfortable and strong grip



ITEM NO.	SIZE (inch/mm)	MAXIMUM JAW OPENING WIDTH (mm)	L (mm)	Hand	Weight (kg)
• AMAA2415	6"(150mm)	23.9	165	5	90
• AMAA2920	8"(200mm)	28.6	210	6	60
• AMAA3325	10"(250mm)	32.8	260	6	48
• AMAA3830	12"(300mm)	38.1	310	6	24

107 **Wrenches & Torque Wrenches**

**Double End Swivel-Socket Wrench**  
 • Chrome Vanadium Steel Material  
 • Unique swivel function in design enables the socket end to rotate through 180° moment for convenient access to confined area



12PT

**POUCH BAG - GREEN** 6PCS  
 Double End Swivel-Socket Wrench Set



ITEM NO.	SIZE(mm)	L(mm)	Mirror Polished	
AEAC0607	6x7	185	10	240
AEAC0809	8x9	180	10	160
AEAC1012	10x12	205	10	80
AEAC1214	12x14	225	10	80
AEAC1415	14x15	242	10	80
AEAC1417	14x17	244	10	80
AEAC1617	16x17	258	5	40
AEAC1719	17x19	260	5	40
AEAC2022	20x22	305	5	30
AEAC2123	21x23	305	5	30

ITEM NO.	CONTENTS	Satin Chrome Finished
GAAA0623	8x9, 10x11, 12x13, 14x15, 16x17, 18x19	6 (SET)

**Double End Swivel-Socket Wrench**  
 • Chrome Vanadium Steel Material  
 • Unique swivel function in design enables the socket end to rotate through 180° moment for convenient access to confined area



12PT

**POUCH BAG - GREEN** 7PCS  
 Double End Swivel-Socket Wrench Set

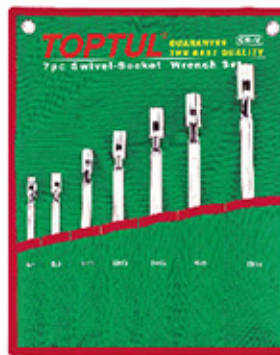

ITEM NO.	SIZE(mm)	L(mm)	Satin Chrome Finished	
AEEC0607	6x7	185	10	240
AEEC0809	8x9	185	10	160
AEEC0810	8x10	185	10	160
AEEC1011	10x11	200	10	80
AEEC1012	10x12	205	10	80
AEEC1213	12x13	220	10	80
AEEC1214	12x14	225	10	80
AEEC1415	14x15	242	10	80
AEEC1417	14x17	244	10	80
AEEC1617	16x17	258	5	40
AEEC1719	17x19	260	5	40
AEEC1819	18x19	270	5	40
AEEC2022	20x22	305	5	30
AEEC2123	21x23	305	5	30

ITEM NO.	CONTENTS	Satin Chrome Finished
GAAA0704	6x7, 8x9, 10x11, 12x13, 14x15, 16x17, 18x19	10 (SET)

**METAL BOX** 7PCS  
 Double End Swivel-Socket Wrench Set



ITEM NO.	CONTENTS	Satin Chrome Finished
GAAD0703	6x7, 8x9, 10x11, 12x13, 14x15, 16x17, 18x19	6 (SET)

METAL CASE: W370 x D154 x H50 (mm)

**POUCH BAG - BLACK** 7PCS  
 Double End Swivel-Socket Wrench Set



ITEM NO.	CONTENTS	Satin Chrome Finished
GPAQ0701	6x7, 8x9, 10x11, 12x13, 14x15, 16x17, 18x19	10 (SET)

**Swivel-Socket Combination Wrench**  
 • Chrome Vanadium Steel Material  
 • Unique swivel function in design enables the socket end to rotate through 180° moment for convenient access to confined area



12PT

ITEM NO.	SIZE(mm)	L(mm)	Mirror Polished	
AEAB0808	8	170	20	240
AEAB0909	9	170	20	240
AEAB1010	10	180	15	180
AEAB1111	11	190	10	120
AEAB1212	12	195	10	120
AEAB1313	13	210	10	80
AEAB1414	14	223	10	80
AEAB1515	15	223	10	80
AEAB1616	16	235	5	40
AEAB1717	17	235	5	40
AEAB1818	18	255	5	40
AEAB1919	19	255	5	40

**Swivel-Socket Combination Wrench**  
 • Chrome Vanadium Steel Material  
 • Unique swivel function in design enables the socket end to rotate through 180° moment for convenient access to confined area



12PT

ITEM NO.	SIZE(mm)	L(mm)	Satin Chrome Finished	
AEEB0808	8	170	20	240
AEEB0909	9	170	20	240
AEEB1010	10	180	15	180
AEEB1111	11	190	10	120
AEEB1212	12	195	10	120
AEEB1313	13	210	10	80
AEEB1414	14	223	10	80
AEEB1515	15	223	10	80
AEEB1616	16	235	5	40
AEEB1717	17	235	5	40
AEEB1818	18	255	5	40
AEEB1919	19	255	5	40

**1/4" Square Drive & Bit Holder Swivel Wrench**  
 • Chrome Vanadium Steel Material  
 • Swivel head design for working in areas with restricted access

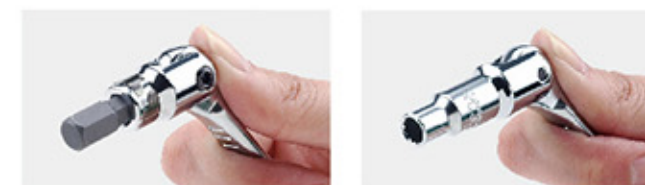

ITEM NO.	SIZE	L(mm)	Dual Finished	
AREA0808	1/4" Dr. x 1/4"	185	10	80

**Angled Socket Wrench**  
 • Chrome Vanadium Steel Material  
 • Unique designed open hole on the angle socket end allows access to nuts fitted onto protruding threads

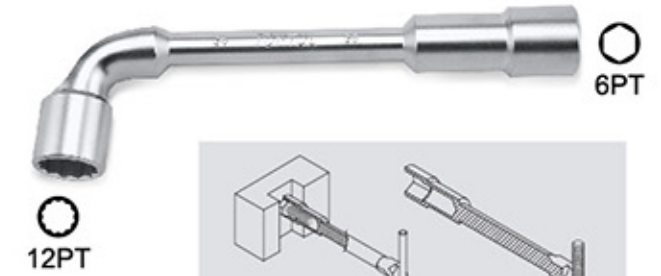

12PT

ITEM NO.	SIZE(mm)	L(mm)	Satin Chrome Finished	
AEAE0606	6	100	10	320
AEAE0707	7	100	10	320
AEAE0808	8	120	10	160
AEAE0909	9	122	10	160
AEAE1010	10	135	10	160
AEAE1111	11	135	10	160
AEAE1212	12	145	5	60
AEAE1313	13	149	5	60
AEAE1414	14	160	5	60
AEAE1515	15	165	5	60
AEAE1616	16	185	5	40
AEAE1717	17	185	5	40
AEAE1818	18	200	5	40
AEAE1919	19	200	2	16
AEAE2020	20	210	2	16
AEAE2121	21	210	2	16
AEAE2222	22	230	2	16
AEAE2323	23	228	2	12
AEAE2424	24	230	2	12
AEAE2525	25	232	2	12
AEAE2626	26	268	2	12
AEAE2727	27	268	2	12
AEAE2828	28	270	2	12
AEAE2929	29	285	2	12
AEAE3030	30	299	2	12
AEAE3232	32	310	2	12

**POUCH BAG - BLACK** 9PCS  
 Angled Socket Wrench Set



ITEM NO.	CONTENTS	Satin Chrome Finished
GPAQ0901	8, 10, 11, 12, 13, 14, 16, 17, 19	6 (SET)

# Wrenches & Torque Wrenches

## Double End Socket Wrench

- Chrome Vanadium Steel Material
- With hexagonal shaft and hole, designed for turning and tightening with steel bar or wrench



• Hollow tube design allows screws may go through

ITEM NO.	SIZE (mm)	L (mm)	Weight (g)	Material
<b>AEBE0607</b>	6x7	105	10	320
<b>AEBE0809</b>	8x9	110	10	160
<b>AEBE1011</b>	10x11	120	10	160
<b>AEBE1213</b>	12x13	140	10	160
<b>AEBE1415</b>	14x15	145	10	160
<b>AEBE1617</b>	16x17	155	8	128
<b>AEBE1819</b>	18x19	165	4	64
<b>AEBE2022</b>	20x22	170	4	64
<b>AEBE2123</b>	21x23	185	4	64
<b>AEBE2426</b>	24x26	190	2	16
<b>AEBE2528</b>	25x28	205	2	16
<b>AEBE2729</b>	27x29	210	2	16
<b>AEBE3032</b>	30x32	212	2	16

## Double-End Truck Wrench W/Bar

- Chrome Vanadium Steel Material
- Wheel nut removal tools
- 6-point socket wrench

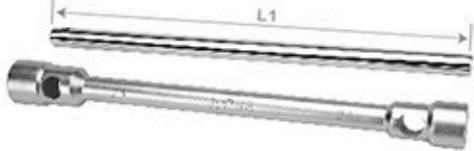

ITEM NO.	SIZE (mm)	Bar Size (Dia. x L1)	L (mm)	Weight (g)	Material
<b>CTIA2427</b>	24 x 27	Ø3/4"x16"	406	2	8
<b>CTIA2730</b>	27 x 30	Ø3/4"x16"	406	2	8
<b>CTIA2732</b>	27 x 32	Ø3/4"x16"	406	2	8
<b>CTIA3032</b>	30 x 32	Ø3/4"x16"	406	2	8
<b>CTIA3233</b>	32 x 33	Ø3/4"x16"	406	2	8
<b>CTIA3238</b>	32 x 38	Ø3/4"x16"	406	2	8

## Double-End Truck Wrench W/Bar

- Chrome Vanadium Steel Material
- For off-road Budd-type wheels

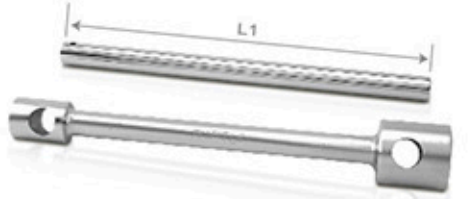

ITEM NO.	SIZE (mm)	Bar Size (Dia. x L1)	L (mm)	Weight (g)	Material
<b>CTIB3517</b>	Ø35 x Ø17 Sq.	Ø1"x16"	330	2	8
<b>CTIB3821</b>	Ø38 x Ø21 Sq.	Ø1"x16"	430	2	8
<b>CTIB4121</b>	Ø41 x Ø21 Sq.	Ø1"x16"	430	2	8

## 4-Way Wheel Nut Wrench

- Chrome Vanadium Steel Material
- Specially designed handle for quick removal of wheel bolts



ITEM NO.	SIZE	L (inch)	Weight (g)	Material
<b>AEAL1616</b>	17 x 19 x 21mm x 1/2" Dr.	16	5	15

## 4-Way Wheel Nut Wrench

- Chrome Vanadium Steel Material
- Specially designed handle for quick removal of wheel bolts



• Heavy-duty forged four way wheel nut wrench. Fits most vans and trucks. 24, 27 and 32mm flange drive hexagons, and 3/4" square drive. Heat treated chrome vanadium alloy steel. Shiny Satin Finish. 22mm dia. Arm length: 700 mm.

ITEM NO.	SIZE	L (inch)	Weight (g)	Material
<b>AEAL2401</b>	24 x 27 x 32mm x 3/4" Dr.	27.5	5	

## Foldable Cross Rim Wrench

- Chrome Vanadium Steel Material

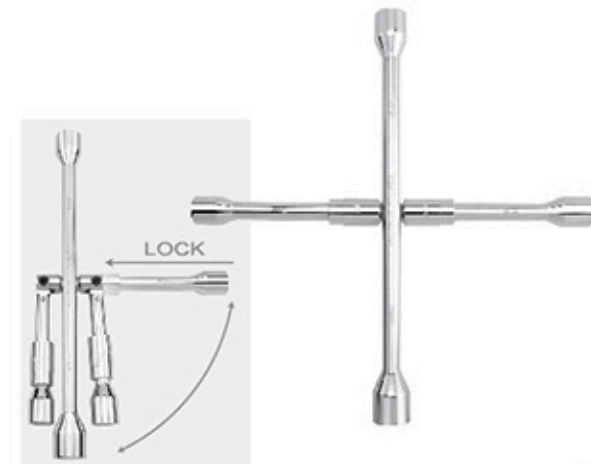

ITEM NO.	SIZE (mm)	L (inch)	Weight (g)	Material
<b>AEAQ2214</b>	17 x 19 x 21 x 22	14	4	16

## Ball Swivel Magnetic Spark Plug Socket T-Handle

- Chrome Vanadium Steel Material

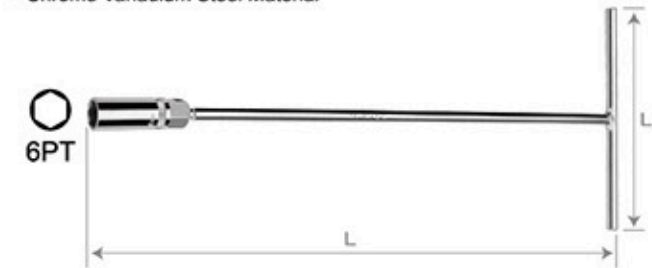

ITEM NO.	SIZE (mm)	L1 (mm)	L (mm)	Weight (g)	Material
<b>CTHA1645</b>	16	200	465	10	40
<b>CTHA2145</b>	21	200	465	10	40

## Sliding T-Handle Socket Wrench



ITEM NO.	SIZE (mm)	L1 (mm)	L (mm)	Weight (g)	Material
<b>CTDA0831</b>	8	200	310	10	40
<b>CTDA0931</b>	9	200	310	10	40
<b>CTDA1031</b>	10	200	310	10	40
<b>CTDA1131</b>	11	200	310	10	40
<b>CTDA1231</b>	12	200	310	10	40
<b>CTDA1331</b>	13	200	310	10	40
<b>CTDA1431</b>	14	200	310	10	40
<b>CTDA1731</b>	17	200	310	10	40
<b>CTDA1931</b>	19	200	310	10	40

## Jointed Socket Sliding T-Wrench

- Made of Chrome Vanadium Steel Material
- Easy to use T-handle tools
- Equipped with universal joint can adjust the operating angle for easy access spots

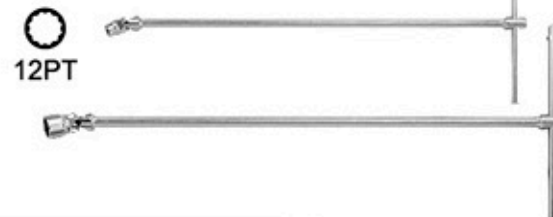

ITEM NO.	SIZE (mm)	Extension Drive	L1 (mm)	L (mm)	Weight (g)	Material
<b>CTKA0806</b>	6	1/4"	160	400	10	40
<b>CTKA0807</b>	7	1/4"	160	400	10	40
<b>CTKA0808</b>	8	1/4"	160	400	10	40
<b>CTKA0809</b>	9	1/4"	160	400	10	40
<b>CTKA1210</b>	10	3/8"	200	450	10	40
<b>CTKA1211</b>	11	3/8"	200	450	10	40
<b>CTKA1212</b>	12	3/8"	200	450	10	40
<b>CTKA1213</b>	13	3/8"	200	450	10	40
<b>CTKA1214</b>	14	3/8"	200	450	10	40
<b>CTKA1215</b>	15	3/8"	200	450	10	40
<b>CTKA1216</b>	16	3/8"	200	450	10	40
<b>CTKA1217</b>	17	3/8"	200	450	10	40
<b>CTKA1218</b>	18	3/8"	200	450	10	40
<b>CTKA1219</b>	19	3/8"	200	450	10	40

## Mini 3 Way T-Handle Socket Wrench

- Made of Chrome Vanadium Steel Material
- Most common sockets sizes in one compact T-type wrench
- Polished chrome finish
- 6-point socket wrench



ITEM NO.	SIZE (mm)	L1 (mm)	L (mm)	Weight (g)	Material
<b>CTMA0810</b>	8x10x12	135	145	30	90

## Ball Swivel Socket Sliding T-Handle

- Chrome Vanadium Steel Material

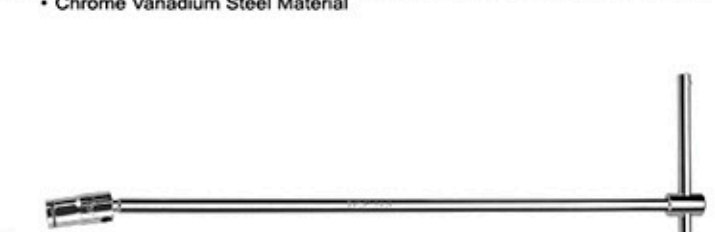

ITEM NO.	SIZE (mm)	L1 (mm)	L (mm)	Weight (g)	Material
<b>CTBA0832</b>	8	200	320	10	40
<b>CTBA1032</b>	10	200	320	10	40
<b>CTBA1132</b>	11	200	320	10	40
<b>CTBA1232</b>	12	200	320	10	40
<b>CTBA1332</b>	13	200	320	10	40
<b>CTBA1432</b>	14	200	320	10	40
<b>CTBA0860</b>	8	200	600	10	40
<b>CTBA1060</b>	10	200	600	10	40
<b>CTBA1160</b>	11	200	600	10	40
<b>CTBA1260</b>	12	200	600	10	40
<b>CTBA1360</b>	13	200	600	10	40
<b>CTBA1460</b>	14	200	600	10	40

## Flexible Drivers with Sliding T-Handle

- Made of Chrome Vanadium Steel Material
- Easy to use T-handle tools
- Use 1/4", 3/8" or 1/2" square drive attachments such as sockets, hex drives, crowfoot wrench or swivels

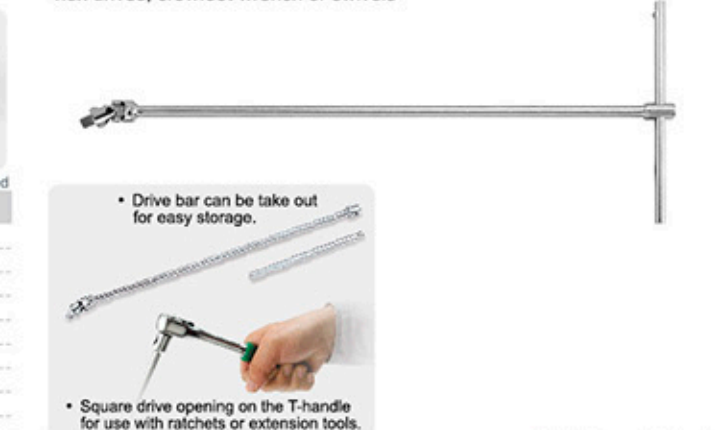

ITEM NO.	DRIVE	Extension Drive	L1 (mm)	L (mm)	Weight (g)	Material
<b>CTLA0840</b>	1/4"	1/4"	160	400	10	40
<b>CTLA1245</b>	3/8"	3/8"	200	450	10	40
<b>CTLA1650</b>	1/2"	1/2"	230	500	10	20

111 **Wrenches & Torque Wrenches**

Hex Nut Driver T-Handle  
• Chrome Vanadium Steel Material

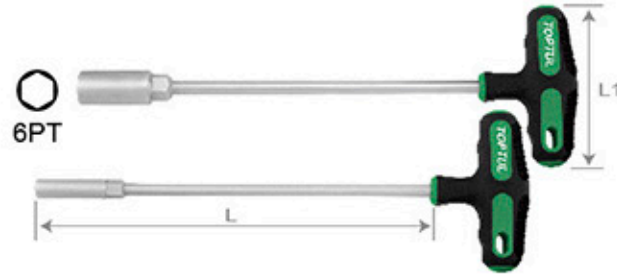

ITEM NO.	SIZE(mm)	L1(mm)	L(mm)	Hand	Weight
Satin Chrome Finished					
CTJA0523	5	95	230	5	30
CTJA0623	6	95	230	5	30
CTJA0723	7	95	230	5	30
CTJA0823	8	95	230	5	30
CTJA0923	9	95	230	5	30
CTJA1023	10	95	230	5	30
CTJA1123	11	95	230	5	30
CTJA1223	12	95	230	5	30
CTJA1323	13	95	230	5	30
CTJA1423	14	95	230	5	30

3/8" Dr. 6PT Flare Nut Crowfoot Wrench  
• Made of drop forged Chrome Molybdenum Alloy Steel (CR-MO)  
• Designed to provide access to the hard to reach fasteners  
• Oversized wrench surfaces grip multiple sides to reduce rounding  
• Chrome plated for maximum durability and corrosion resistance  
• Ideal for use on soft fittings in aluminum, copper and brass



ITEM NO.	SIZE(mm)	L(mm)	Hand	Weight
Satin Finished				
AEAV1210	10	36	40	400
AEAV1211	11	38	40	400
AEAV1212	12	38	40	400
AEAV1213	13	43	30	300
AEAV1214	14	43	30	300
AEAV1215	15	44	30	300
AEAV1216	16	44	30	300
AEAV1217	17	48	30	300
AEAV1218	18	48	30	300
AEAV1219	19	49	30	300

8PCS Hex Nut Driver T-Handle Set



ITEM NO.	GZC0802	Weight	5 (SET)
CONTENTS	CTJA0723-CTJA1423 Hex Nut Driver T-Handle 7, 8, 9, 10, 11, 12, 13, 14 mm		
PLASTIC BOX: W373 x D289 x H56 (mm)			

3/8" Dr. 6PT Flare Nut Crowfoot Wrench  
• Made of drop forged Chrome Molybdenum Alloy Steel (CR-MO)  
• Designed to provide access to the hard to reach fasteners  
• Oversized wrench surfaces grip multiple sides to reduce rounding  
• Chrome plated for maximum durability and corrosion resistance  
• Ideal for use on soft fittings in aluminum, copper and brass



ITEM NO.	SIZE(inch)	L(mm)	Hand	Weight
Satin Finished				
AFAV1212	3/8	36	40	400
AFAV1214	7/16	38	40	400
AFAV1216	1/2	43	30	300
AFAV1218	9/16	43	30	300
AFAV1220	5/8	44	30	300
AFAV1222	11/16	48	30	300
AFAV1224	3/4	49	30	300
AFAV1228	7/8	56	20	200

10PCS 3/8" Dr. 6PT Flare Nut Crowfoot Wrench Set (METRIC)



ITEM NO.	GAAR1001	CONTENTS	Weight	10 (SET)
AEAV1210-1219 10, 11, 12, 13, 14, 15, 16, 17, 18, 19 mm				

8PCS 3/8" Dr. 6PT Flare Nut Crowfoot Wrench Set (SAE)



ITEM NO.	GBAR0801	CONTENTS	Weight	10 (SET)
AFAV1212-1228 3/8", 7/16", 1/2", 9/16", 5/8", 11/16", 3/4", 7/8"				



Digital Torque Wrench

- Torque Accuracy: CW ±1% & CCW ±1.5% tolerance of the set scale value
- Precise reading accuracy for a minimum 5,000 tightening cycles
- Operating Mode: Peak hold mode (peak value detection) / Track mode (continuous display)
- Torque Unit Selection: Nm, Ft-Lb, In-Lb, Kg-m
- Storage Memory: 10 Readings
- Three way lights and buzzer when torque value is reached
- Low battery indicator and auto shut off (after 65 seconds)
- 3 Position, 32 Teeth Ratcheting Mechanism: Clockwise / Fixed / Counterclockwise
- Ergonomically designed bi-component soft grip handle
- Tested and certified according to DIN EN ISO 6789, BS EN 26789



Torque Accuracy	CW ± 1% / CCW ± 1.5%
Storage Memory	10 Readings
Torque Unit Selection	Nm, Ft-Lb, In-Lb, Kg-m
Display Resolution	0.1 Nm, 0.1 Ft-Lb, 1 In-Lb, 0.01 Kg-m
Operating Mode	Peak Hold Mode / Track Mode
Gear Teeth	32 Precision Teeth
Ratcheting Mechanism	Clockwise / Fixed / Counterclockwise
Working Temperature	-15°C ~ 55°C
Storage Temperature	-40°C ~ 85°C
Humidity	0 ~ 90%
Battery	1.5V AA x 3pcs
Battery Life	200 Hours
Auto Shut Off	65 Seconds (when not in use)

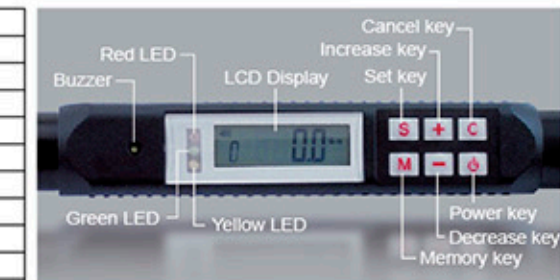

ITEM NO.	DRIVE	(Nm)	Torque Range (Ft-Lb)	(In-Lb)	(Kg-m)	L (mm)	Weight
DT-100N	3/8"	10-100	7.3-73.7	88-885	1.02-10.20	440	12
DT-200N	1/2"	20-200	14.7-147.5	176-1769	2.03-20.38	530	6



**TOPTUL**  
YOUR BEST WORKING PARTNERS



**Digital Torque Adapter**

- Torque Accuracy: CW  $\pm 2\%$  & CCW  $\pm 2\%$  tolerance of the set scale value
- Precise reading accuracy for a minimum 5000 tightening cycles
- Operating Mode: Peak hold mode (peak value detection) / Track mode (continuous display)
- Torque Unit Selection: Nm, Ft-Lb, In-Lb, Kg-m, Kg-cm
- Storage Memory: 10 Sets
- Low battery indicator and auto shut off (after 3 minutes)
- Large LCD Display for clear reading
- Tested and certified according to DIN EN ISO 6789, BS EN 26789
- Buzzer & LED indication for pre-settable target torque

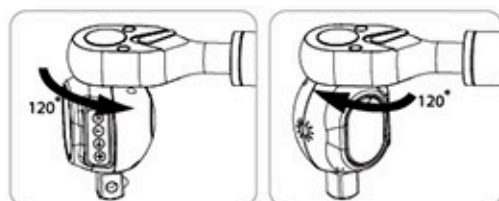

Rotatable mechanism design can reach total 240° view area for easily reading the torque value on the LCD display.



Torque Accuracy	CW $\pm 2\%$ / CCW $\pm 2\%$
Storage Memory	10 Sets
Torque Unit Selection	Nm, Ft-Lb, In-Lb, Kg-m, Kg-cm
Display Resolution	0.1 Nm, 0.1 Ft-Lb, 1 In-Lb, 0.01 Kg-m, 1Kg-cm
Operating Mode	Peak Hold Mode / Track Mode
Working Temperature	-10°C ~ 60°C
Storage Temperature	-20°C ~ 70°C
Humidity	0 ~ 90%
Battery	3V CR2032 x 1pc
Battery Life	50 Hours
Auto Shut Off	3 Minutes (when not in use)



ITEM NO.	DRIVE	Torque Range			L (mm)	⚙️
		(Nm)	(Ft-Lb)	(In-Lb)		
DTA-200N	1/2"	40~200	29.5~147.6	354~1770	75	48



**TOPTUL**  
MICROMETER ADJUSTABLE  
TORQUE WRENCH

**Micrometer Adjustable Torque Wrench (Window Display)**

- Chrome Molybdenum Steel Ratchet Head
- Spring ball socket retention and push-button quick release
- Push to lock / pull to unlock scale setting feature
- Large digits for exact and easy-to-read torque setting
- Convex display simplified reading
- Ergonomically designed, Nylon material anti-slip handle
- Tolerance of torque accuracy  $\pm 3\%$



Safety Locking Design



Easy Reading Screen



ITEM NO.	DRIVE	CAPACITY	L(mm)	⚙️	48 Gears
ANAU0803	1/4"	5~25 Nm	323	6	
ANAU1210	3/8"	20~100 Nm	400	6	
ANAU1620	1/2"	40~200 Nm	517	6	

**Micrometer Adjustable Torque Wrench (Window Display)**

- Chrome Molybdenum Steel Ratchet Head
- Push to lock / pull to unlock scale setting feature
- Large digits for exact and easy-to-read torque setting
- Convex display simplified reading
- Ergonomically designed, Nylon material anti-slip handle
- Tolerance of torque accuracy  $\pm 3\%$



Safety Locking Design



Easy Reading Screen



ITEM NO.	DRIVE	CAPACITY	L(mm)	⚙️	48 Gears
ANAU2475	3/4"	150~750 Nm	1210	2	
ANAU32A0	1"	200~1000 Nm	1500	1	



# Wrenches & Torque Wrenches

## Micrometer Adjustable Torque Wrench

- Chrome Vanadium Steel Ratchet Head
- 3-Way Ratchet Drive Mechanism: Forward / Lock / Reverse
- Quick release button ensures firm socket retention and easy socket removal
- Easy torque adjustment, positive lock with spring loaded pull-down lock ring
- Applied to test torque clockwise and counterclockwise direction
- Comfortable ergonomic handle
- Tolerance of torque accuracy  $\pm 4\%$  CW and  $\pm 6\%$  CCW



ITEM NO.	DRIVE	CAPACITY	L(mm)	32 Gears
ANAS0803	1/4"	6-30Nm	260	20
ANAS1211	3/8"	20-110Nm	435	10
ANAS1621	1/2"	40-210Nm	495	10
ANAS1635	1/2"	70-350Nm	560	6

## Micrometer Adjustable Torque Wrench

- Chrome Vanadium Steel Ratchet Head
- 3-Way Ratchet Drive Mechanism: Forward / Lock / Reverse
- Easy torque adjustment, positive lock with spring loaded pull-down lock ring
- Applied to test torque clockwise and counterclockwise direction
- Comfortable ergonomic handle
- Tolerance of torque accuracy  $\pm 4\%$  CW and  $\pm 6\%$  CCW



ITEM NO.	DRIVE	CAPACITY	L(mm)	36 Gears
ANAS2480	3/4"	100-800Nm	1000	2

## Torque Wrench

- CR-V/CR-MO Steel Ratchet Head
- Equip flip reverse ratchet action function
- Unique push to lock/pull to unlock scale setting feature
- Ergonomically designed, TPR material anti-slip handle
- Tolerance of torque accuracy  $\pm 4\%$



ITEM NO.	DRIVE	CAPACITY	L(mm)	24 Gears
ANAG0825	1/4"	40-250in-LB	350	20
ANAG1225	3/8"	40-250in-LB	350	20
ANAG1208	3/8"	15-80Ft-LB	385	12
ANAG1615	1/2"	30-150Ft-LB	535	10
ANAG1625	1/2"	50-250Ft-LB	645	6
ANAG2430	3/4"	50-300Ft-LB	865	4

## Torque Wrench

- CR-V/CR-MO Steel Ratchet Head
- Equip flip reverse ratchet action function
- Unique push to lock/pull to unlock scale setting feature
- Ergonomically designed, TPR material anti-slip handle
- Tolerance of torque accuracy  $\pm 4\%$



ITEM NO.	DRIVE	CAPACITY	L(mm)	24 Gears
ANAF0803	1/4"	6-30Nm	350	20
ANAF1203	3/8"	6-30Nm	350	20
ANAF1211	3/8"	20-110Nm	385	12
ANAF1621	1/2"	40-210Nm	535	10
ANAF1635	1/2"	70-350Nm	645	6
ANAF2450	3/4"	100-500Nm	865	4

## Torque Wrench

- CR-MO Steel Ratchet Head
- Equip flip reverse ratchet action function
- Unique push to lock/pull to unlock scale setting feature
- Tolerance of torque accuracy  $\pm 4\%$



• Torque Wrench  
- ANAA2470 (140-700Nm)



• Torque Wrench  
- ANAB2460 (100-600Ft-LB)

ITEM NO.	DRIVE	CAPACITY	L(mm)	24 Gears
ANAA2470	3/4"	140-700Nm	1092	4
ANAA2498	3/4"	140-980Nm	1230	2
ANAA3298	1"	140-980Nm	1230	2

## 11PCS 1/2" DR. Torque Wrench Set



ITEM NO.	CONTENTS	6 (SET)
GAAI1102	<ul style="list-style-type: none"> <li>• ANAF1621 1/2" Dr. Torque Wrench (40-210Nm)</li> <li>• BAEA1617-1627 1/2" Dr. 6PT Flank Sockets 17, 19, 21, 22, 24, 27 mm</li> <li>• BCDA1606-1612 1/2" Dr. Hex Bit Sockets 6, 8, 10, 12 mm</li> </ul>	

BLOW CASE: W588 x D80 x H74 (mm)

## Torque Wrench

- CR-MO Steel Ratchet Head
- Equip flip reverse ratchet action function
- Unique push to lock/pull to unlock scale setting feature
- Tolerance of torque accuracy  $\pm 4\%$

ITEM NO.	DRIVE	CAPACITY	L(mm)	24 Gears
ANAB2460	3/4"	100-600Ft-LB	1092	4
ANAB2470	3/4"	100-700Ft-LB	1230	2
ANAB3270	1"	100-700Ft-LB	1230	2



**TOPTUL**  
MICROMETER ADJUSTABLE TORQUE WRENCH





**TOPTUL**  
TORQUE WRENCHES SERIES

**Micrometer Adjustable Torque Wrench (Window Display)**

- Chrome Molybdenum Steel Ratchet Head
- Flip reverse ratchet action
- Spring ball socket retention and push-button quick release
- Push to lock / pull to unlock scale setting feature
- Large digits for exact and easy-to-read torque setting
- Convex display simplifies reading
- Ergonomically designed, Nylon material anti-slip handle
- Tolerance of torque accuracy  $\pm 3\%$



ITEM NO.	DRIVE	CAPACITY	L(mm)	45 Gears
ANAM0803	1/4"	1-25Nm	290	10
ANAM1205	3/8"	5-50Nm	360	10
ANAM1610	1/2"	10-100Nm	405	10
ANAM1620	1/2"	20-200Nm	500	10
ANAM1630	1/2"	60-300Nm	595	10
ANAM1640	1/2"	80-400Nm	680	8

**Interchangeable Torque Handle**



ITEM NO.	HEAD SIZE	CAPACITY	L(mm)
ANAH0303	9x12	6-30Nm	280
ANAH0108	14x18	10-80Nm	360
ANAH0121	14x18	40-210Nm	509

**Interchangeable Torque Handle (Window Display)**



ITEM NO.	HEAD SIZE	CAPACITY	L(mm)
ANAJ0130	14x18	60-300Nm	575

**Ratchet Head**

- CR-MO Steel Ratchet Head
- 24 teeth



ITEM NO.	HEAD SIZE	DRIVE	L(mm)
ANAL0412	9x12	3/8"	56
ANAL0216	14x18	1/2"	78
ANAL0116	14x18	1/2"	94

**Spanner Head**

- CR-V Steel Head



ITEM NO.	HEAD SIZE	SIZE(mm)	L(mm)
ANAR0307	9x12	7	42
ANAR0308	9x12	8	42
ANAR0309	9x12	9	44
ANAR0310	9x12	10	45
ANAR0311	9x12	11	45
ANAR0312	9x12	12	46
ANAR0313	9x12	13	49
ANAR0314	9x12	14	50
ANAR0113	14x18	13	70
ANAR0114	14x18	14	70
ANAR0115	14x18	15	70
ANAR0116	14x18	16	73
ANAR0117	14x18	17	73
ANAR0119	14x18	19	75
ANAR0122	14x18	22	77
ANAR0124	14x18	24	78
ANAR0126	14x18	26	78
ANAR0127	14x18	27	82
ANAR0129	14x18	29	85
ANAR0130	14x18	30	87
ANAR0132	14x18	32	87

**Spanner Head**

- CR-V Steel Head



ITEM NO.	HEAD SIZE	SIZE(mm)	L(mm)
ANAK0307	9x12	7	37
ANAK0308	9x12	8	37
ANAK0309	9x12	9	38
ANAK0310	9x12	10	39
ANAK0311	9x12	11	39
ANAK0312	9x12	12	40
ANAK0313	9x12	13	42
ANAK0314	9x12	14	42
ANAK0315	9x12	15	42
ANAK0316	9x12	16	43
ANAK0317	9x12	17	43
ANAK0318	9x12	18	46
ANAK0319	9x12	19	46
ANAK0113	14x18	13	63
ANAK0114	14x18	14	63
ANAK0115	14x18	15	64
ANAK0116	14x18	16	64
ANAK0117	14x18	17	64
ANAK0118	14x18	18	65
ANAK0119	14x18	19	65
ANAK0121	14x18	21	66
ANAK0122	14x18	22	66
ANAK0124	14x18	24	67
ANAK0126	14x18	26	70
ANAK0127	14x18	27	70
ANAK0129	14x18	29	74
ANAK0130	14x18	30	74
ANAK0132	14x18	32	77
ANAK0134	14x18	34	82
ANAK0136	14x18	36	82
ANAK0138	14x18	38	82
ANAK0141	14x18	41	83
ANAK0146	14x18	46	86

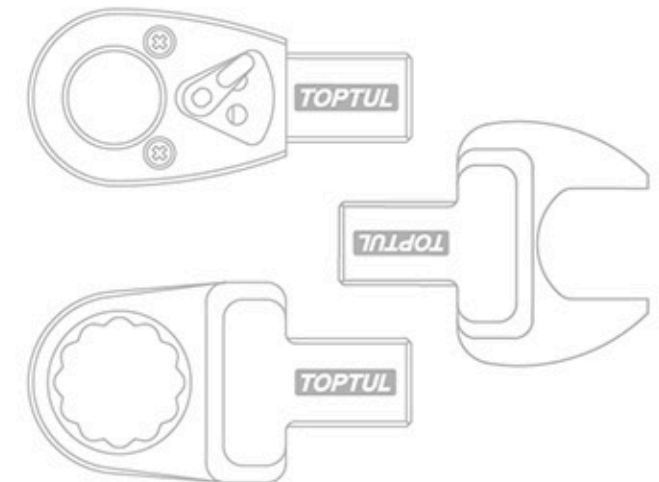



**TOPTUL**  
TORQUE WRENCHES SERIES

**8PCS**  
1/2" DR. Head-Interchangeable Spanner Torque Wrench Set



ITEM NO.	CONTENTS	6 (SET)
GAAI0801	1 ANAH0108 14x18 Head Size Interchangeable Torque Handle (10-80Nm)	
	1 ANAL0216 1/2" Dr. Ratchet Head	
	1 ANAK0117-0129 Spanner Head 17, 22, 24, 26, 27, 29 mm	

BLOW CASE: W420 x D210 x H55 (mm)

**10PCS**  
3/8" DR. Head-Interchangeable Spanner Torque Wrench Set



ITEM NO.	CONTENTS	10 (SET)
GAAI1001	1 ANAH0303 9x12 Head Size Interchangeable Torque Handle (6-30Nm)	
	1 ANAL0412 3/8" Dr. Ratchet Head	
	1 ANAK0307-0314 Spanner Head 7, 8, 9, 10, 11, 12, 13, 14 mm	

BLOW CASE: W360 x D140 x H64 (mm)

**11PCS**  
1/2" DR. Head-Interchangeable Spanner Torque Wrench Set



ITEM NO.	CONTENTS	4 (SET)
GAAI1101	1 ANAH0121 14x18 Head Size Interchangeable Torque Handle (40-210Nm)	
	1 ANAL0116 1/2" Dr. Ratchet Head	
	1 ANAK0113-0130 Spanner Head 13, 14, 15, 17, 19, 22, 24, 27, 30 mm	

BLOW CASE: W545 x D146 x H55 (mm)

**1/2" DR. Torque Wrench**  
• This torque wrench is accurate to  $\pm 4\%$  of the set load and has been manufactured and tested in accordance with DIN3122 & ISO 6789.

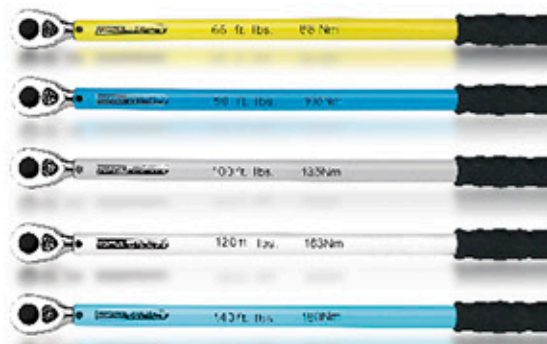

ITEM NO.	CAPACITY	L(mm)	32 Gears
ANAC1607	65Ft-LB/88 Nm	578	12
ANAC1608	80Ft-LB/108 Nm	578	12
ANAC1610	100Ft-LB/135 Nm	578	12
ANAC1612	120Ft-LB/163 Nm	578	12
ANAC1614	140Ft-LB/190 Nm	578	12

**2PCS**  
1/4" DR. Torque Screwdriver Set  
• Easy to read window scale  
• Clockwise operation device  
• 1/4" square driver head for sockets, bit holders and accessories  
• Micrometer scale graduation: 0.5 Nm  
• Actuation accuracy:  $\pm 6\%$  tolerance of the set scale value  
• Test certificate in accordance with DIN EN ISO 6789 national standard



ITEM NO.	CONTENTS	30 (SET)
GCAI0201	1 ANAD0808 1/4" Dr. Torque Screwdriver 1-8 Nm (L=153mm)	
	1 FTAB0808 1/4" Dr. x 1/4" (H) Quick Change Bit Holder (L=25mm)	

BLOW CASE: W200 x D68 x H57 (mm)

**1/4" Hex Drive Torque Screwdriver** -NEW  
• Clockwise and counterclockwise operation device  
• 1/4" female hexagon drive for use with 1/4" hexagon bits  
• Actuation accuracy:  $\pm 6\%$  tolerance of the set scale value  
• Test certificate in accordance with DIN ISO 6789 national standard  
• Ergonomically designed anti-slip grip handle



ITEM NO.	CAPACITY	1 ON FINE SCALE	L(mm)	24
ANCD081B	10-120 cNm	1 cNm	180	24
ANCD0806	1-6 Nm	0.1 Nm	200	24

**2PCS**  
1/4" Hex Drive Torque Screwdriver Set  
• Reduced weight and size specifically designed for low torque application  
• Clockwise operation device  
• Easy to read window scale  
• 1/4" female hexagon drive for use with 1/4" hexagon bits  
• Ease of use, additional 1/4" female square drive on the handle accommodates T-handle, ratchet handle and etc.  
• Micrometer scale graduation: 0.1 Nm  
• Actuation accuracy:  $\pm 6\%$  tolerance of the set scale value  
• Test certificate in accordance with DIN EN ISO 6789 national standard



ITEM NO.	CONTENTS	30 (SET)
GCAI0202	1 ANBD0808 1/4" Hex Drive Torque Screwdriver 1.5-8 Nm (L=162mm)	
	1 CTCK0811 1/4" Dr. Sliding T-Handle (L=115mm)	

BLOW CASE: W200 x D68 x H57 (mm)

**Professional Grade**  
Torque Tester (Calibrator)



ITEM NO.	IEA040400
<b>TECHNICAL SPECIFICATION</b>	
Calibration Range	40-400 Nm
Display	5 alphanumeric digits max.
Accuracy	$\pm 0.5\%$
Units of Measurement	Nm, Ft-Lb, In-Lb, Kg-cm
Operating Temperature	+5°C--40°C
Storage Temperature	0°C--50°C
Operating Humidity	25-85 % RH
Power Supply	90-260 V.A.C. at 50/60 Hz.
Power Consumption	Less than 1.5 Watt
Power Cable	1.8 Meter
Base Material	Anodized Aluminum Alloy
Dimension	850(L)x650(W)x450(H) mm
PC Connection	RS 232
Net Weight	38.2Kg

(\*Includes 3 Test Drive Adapter: 3/8", 1/2" & 3/4" S.Q. Drive)

121 **Wrenches & Torque Wrenches**

**Torque Multiplier**

- Torque Multiplier is made of Chrome Molybdenum Alloy Steel
- Tolerance of torque accuracy ±6%

DIN3122



ITEM NO.	SIZE (CAPACITY)	Hand	Case
ANAE1624	1/2"(F)x3/4"(M) INPUT(MAX.): 500Nm / 365Ft-LB OUTPUT(MAX.): 1500Nm / 1100Ft-LB	1	4
ANAE2432	3/4"(F)x1"(M) INPUT(MAX.): 1000Nm / 730Ft-LB OUTPUT(MAX.): 3000Nm / 2200Ft-LB	1	4

BLOW CASE: W426 x D208 x H105 (mm)

**Reaction Arm**

- Chrome-Molybdenum Steel
- Accessory kits for ANAE series only

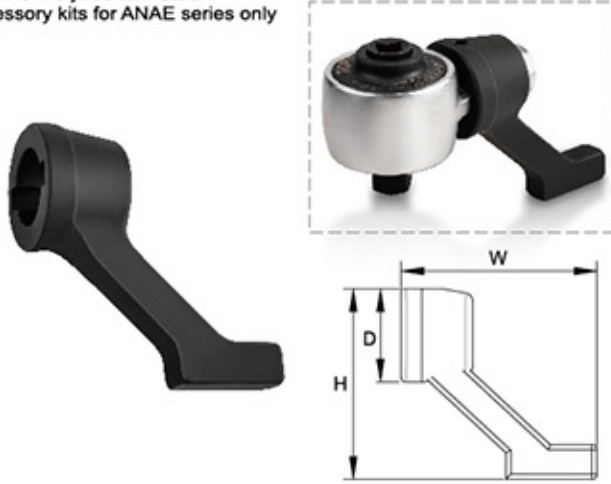

ITEM NO.	SIZE(W)x(D)x(H)mm	Application	Hand	Case
ALAE162414	115x55x117	ANAE1624	2	16
ALAE243214	150x72x155	ANAE2432	2	8

**3PCS**

**Industrial Torque Multiplier Set**

- Torque Multiplier is made of Chrome Molybdenum Alloy Steel
- High-efficiency planetary gear sets achieve high output torque from low input torque
- Additional safety break-away adapter to prevent direct damages to multiplier in case of overload
- Special anti backlash device can prevent incidental reverse force during operation
- Include reaction arm can easy to adjust reaction square and firm on an adjacent screw with an impact socket
- Gear Ratio - 1:5.5 Torque Ratio - 1:4.8
- Tolerance of torque accuracy ±5%
- Applications : Industry, construction sites, car and truck garages, agricultural technology, bridge, aircraft and railway construction, shipbuilding, refineries and etc.

- NEW



- Safety Break-Away Adapter will protect and prevent the torque multiplier from damages caused by an overload.

ITEM NO.	CONTENTS	Case
ANDE2448	1 Torque Multiplier 3/4" (F) x 1-1/2" (M) Input (Max.): 938Nm / 691Ft-Lb Output (Max.): 4500Nm / 3320Ft-Lb 1 Safety Break-Away Adapter	1 (SET)

BLOW CASE: W450 x D225 x H160 (mm)

- NEW

**2PCS**

**Torque Multiplier Set**

- Torque Multiplier is made of Chrome Molybdenum Alloy Steel
- High-efficiency planetary gear sets achieve high output torque from low input torque
- Gear Ratio - 1:12.8 Torque Ratio - 1:10
- Tolerance of torque accuracy ±6%
- Bar type design for easy access in confined spaces
- Applications : Industry, construction sites, car and truck garages, agricultural technology, bridge, aircraft and railway construction, shipbuilding, refineries and etc.



ITEM NO.	CONTENTS	Case
ANCE1624	1 Torque Multiplier 1/2" (F) x 3/4" (M) Input (Max.): 150Nm / 110Ft-Lb Output (Max.): 1500Nm / 1100Ft-Lb 1 Reaction Arm	4 (SET)

BLOW CASE: W355 x D165 x H83 (mm)

**5PCS**

**Torque Multiplier Set**

- Torque Multiplier is made of Chrome Molybdenum Alloy Steel
- High-efficiency planetary gear sets achieve high output torque from low input torque
- Gear Ratio - 1:12.8 Torque Ratio - 1:10
- Tolerance of torque accuracy ±6%
- Bar type design for easy access in confined spaces
- Special anti backlash device can prevent incidental reverse force during operation
- Applications : Industry, construction sites, car and truck garages, agricultural technology, bridge, aircraft and railway construction, shipbuilding, refineries and etc.

- NEW



• Anti Backlash Device



ITEM NO.	CONTENTS	Case
ANCE1648	1 Torque Multiplier 1/2" (F) x 1-1/2" (M) Input (Max.): 400Nm / 290Ft-Lb Output (Max.): 4000Nm / 2900Ft-Lb 1 Reaction Arm 1 Support Stand 1 Screw 1 Adapter 1 1-1/2" (F) x 1" (M)	1 (SET)

BLOW CASE: W358 x D315 x H130 (mm)



123 **Wrenches & Torque Wrenches**

- 5PCS**  
Torque Multiplier Set
- Torque Multiplier is made of Chrome Molybdenum Alloy Steel
  - High-efficiency planetary gear sets achieve high output torque from low input torque
  - Gear Ratio - 1:12 Torque Ratio - 1:9
  - Supplied with two reaction arm styles for maximum versatility
  - Additional safety break-away adapter to prevent direct damages to multiplier in case of overload

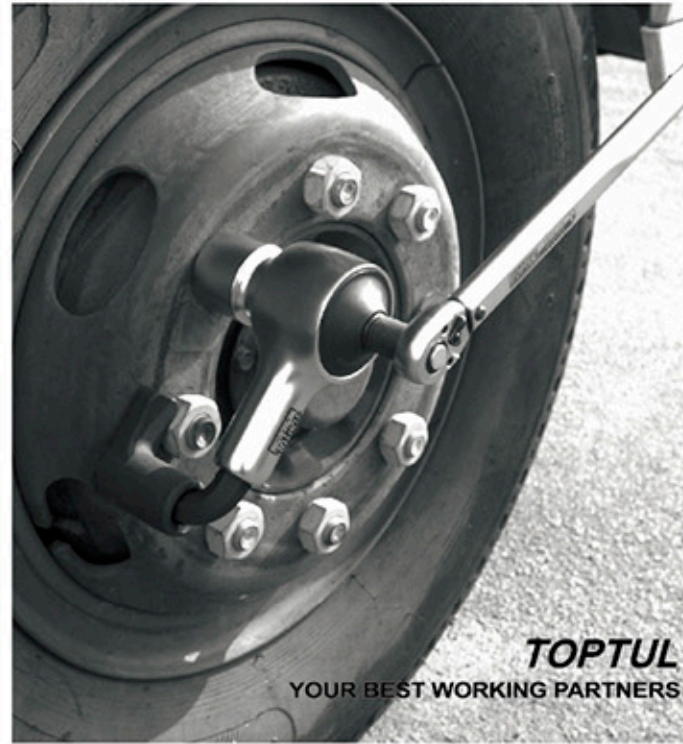

**TOPTUL**  
YOUR BEST WORKING PARTNERS

ITEM NO.	CONTENTS	2 (SET)
ANBE1632	1 Torque Multiplier 1/2" (F) x 1" (M) Input (Max.): 222Nm / 164Ft-Lb Output (Max.): 2000Nm / 1475Ft-Lb 1 Reaction Arm 1 Safety Break-Away Adapter 1 90° Reaction Arm 1 90° Reaction Base	
BLOW CASE: W400 x D260 x H110 (mm)		

- 5PCS**  
Torque Multiplier Set
- Gear Ratio - 1:4 Torque Ratio - 1:3.3



ITEM NO.	CONTENTS	2 (SET)
ANBE2432	1 Torque Multiplier 3/4" (F) x 1" (M) Input (Max.): 758Nm / 560Ft-Lb Output (Max.): 2500Nm / 1845Ft-Lb 1 Reaction Arm 1 Safety Break-Away Adapter 1 90° Reaction Arm 1 90° Reaction Base	
BLOW CASE: W400 x D260 x H110 (mm)		

Use the attached hex key to fix the adapter to the torque multiplier square opening/female drive. (tightening the screw inside the square opening)

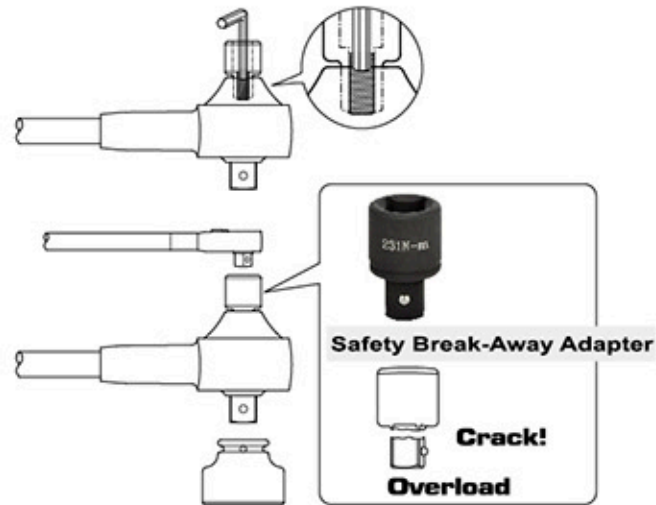

The safety break-away adapter is inserted into the square opening of the torque multiplier. In case of an overload, the adapter will break first instead of cause a damage directly to the torque multiplier.



90° Reaction Arm can be adjusted in the reaction base to use with both standard and deep sockets.

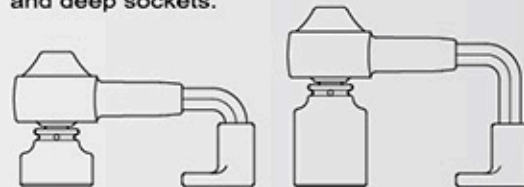

**Hand Sockets, Bit Sockets & Accessories Series**  
**Full**

range of flank sockets with maxi-drive. Available in 1/4", 3/8", 1/2", 3/4" & 1".

www.toptul.com

**HAND SOCKETS, BIT SOCKETS & ACCESSORIES SERIES**

